

Winter 2018

Human-Robot Collaborative Force-Controlled Micro-Drilling for Advanced Manufacturing and Medical Applications

Parimal Mahesh Prajapati
Old Dominion University

Follow this and additional works at: https://digitalcommons.odu.edu/mae_etds

 Part of the [Aerospace Engineering Commons](#), and the [Mechanical Engineering Commons](#)

Recommended Citation

Prajapati, Parimal M.. "Human-Robot Collaborative Force-Controlled Micro-Drilling for Advanced Manufacturing and Medical Applications" (2018). Master of Science (MS), thesis, Mechanical & Aerospace Engineering, Old Dominion University, DOI: 10.25777/rt8j-3s31
https://digitalcommons.odu.edu/mae_etds/173

This Thesis is brought to you for free and open access by the Mechanical & Aerospace Engineering at ODU Digital Commons. It has been accepted for inclusion in Mechanical & Aerospace Engineering Theses & Dissertations by an authorized administrator of ODU Digital Commons. For more information, please contact digitalcommons@odu.edu.

**HUMAN-ROBOT COLLABORATIVE FORCE-CONTROLLED MICRO-DRILLING
FOR ADVANCED MANUFACTURING AND MEDICAL APPLICATIONS**

by

Parimal Mahesh Prajapati
B.S. Aeronautics May 2015, Mumbai University

A Thesis Submitted to the Faculty of
Old Dominion University in Partial Fulfillment of the
Requirements for the Degree of

MASTER OF SCIENCE

MECHANICAL & AEROSPACE ENGINEERING

OLD DOMINION UNIVERSITY
December 2018

Approved by:

KN. Kaipa (Director)

O. G. Kravchenko (Member)

S. Bawab (Member)

ABSTRACT

HUMAN-ROBOT COLLABORATIVE FORCE-CONTROLLED MICRO-DRILLING FOR ADVANCED MANUFACTURING AND MEDICAL APPLICATIONS

Parimal Mahesh Prajapati
Old Dominion University, 2018
Director: Dr. Krishnanand Kaipa

Robotic drilling finds applications in diverse fields ranging from advanced manufacturing to the medical industry. Recent advances in low-cost, and human-safe, collaborative robots (e.g., Sawyer) are enabling us to rethink the possibilities in which robots can be deployed for such tedious and time-consuming tasks. This thesis presents a robotic drilling methodology with features of force-control enabled micro-drilling and human-robot collaboration to reduce programming efforts and enhance drilling performance. A Sawyer robot from Rethink Robotics, which offers safe physical interactions with a human co-worker, kinesthetic teaching, and force control, is used as the test bed. The robot's end-effector was equipped with a Dremel drill fit into a housing, which was custom designed and 3D-printed using an Object Prime 3D-printer. The proposed approach applies human-robot collaboration in two cases. First, a human kinesthetically teaches a set of drill coordinates by physically holding the robot and guiding it to those locations. The robot then executes the drilling task by moving to these recorded locations. This thereby avoids the need to specify the drill coordinates with respect to a fixed reference frame, leading to reduction in programming effort and setup time while transitioning between different drilling jobs. Second, drilled hole quality is shown to be enhanced when a human provides nominal physical support to the robot during certain drilling tasks. An experimental analysis of the impact of force control on micro-drilling revealed that the proposed robotic system is capable of successfully drilling holes with a drill bit of 0.5 mm diameter with an error of ± 0.05 mm, without breaking it

for more than 100 holes. The proposed robotic drilling was validated in the following application domain: micro-drilling for composite repairs based on the through-thickness reinforcement (TTR) technique. For this purpose, sandwich beam samples were prepared by using pre-preg unidirectional carbon fabric face sheets with a honeycomb core, and they were subjected to four-point static loading until de-bonding occurred between the face sheet and the core. The samples were then repaired using the TTR technique, where the proposed robotic drilling was used to drill holes of 0.75 mm diameter in the damaged area of the sample and carbon fiber rods and with low-viscosity epoxy, were manually inserted into these drilled holes. The results revealed that the sandwich beam regained effective compressive strength after going through the TTR technique. Experiments also reveal the potential of the proposed robotic drilling technique in aerospace and automotive manufacturing involving drilling in complex postures and micro-drilling for orthopedic applications.

Copyright, 2018, by Parimal Mahesh Prajapati, All Rights Reserved

This Thesis is dedicated to my parents and my wife who supported me with all throughout my study

NOMENCLATURE

TTR	Through Thickness Reinforcement
DOF	Degrees Of Freedom
MTS	MTS systems Corporations
HRC	Human Robot Collaboration
COBOT	Collaborative Robot
DIC	Digital Image Correlation
BMD	Bending Moment Diagram
SFD	Shear force Diagram
Ø	Diameter

TABLE OF CONTENTS

	Page
LIST OF FIGURES	viii
LIST OF TABLES	x
1. INTRODUCTION	1
1.1 Motivation: Non-Repetitive, Micro-Drilling, Tasks	1
1.2 Thesis Goals and Contributions	3
1.2.1 Human-Robot Collaboration	3
1.2.2 Force-Controlled Micro-Drilling	5
1.2.3 Targeted Application Domains	5
2. RELATED WORK	6
2.1 Robotic Drilling for Aerospace and Automotive Applications	7
2.2 Robotic Drilling for Medical Applications	9
2.3 Force Control for Robotic Drilling	10
2.4 Drilling Performance Metrics	10
2.5 Micro-Drilling	11
2.6 Human-Robot Collaboration	12
2.7 Composite Repair	13
3. ROBOTIC DRILLING METHODOLOGY	15
3.1 Goals	15
3.2 Sawyer Robot from Rethink Robotics	15
3.3 Drill Housing Design	17
3.4 Human Robot Collaboration Strategies	20
3.4.1 Kinesthetic Teaching of Drill Coordinates	20
3.4.2 Human support during drilling	21
3.5 Force control for Robotic Micro-drilling	27
4. COMPOSITE REPAIR USING THROUGH THICKNESS REINFORCEMENT (TTR) TECHNIQUE	32
4.1 Design and making of Sandwich Beams	32
4.2 Test setup for four-point bend test	34
4.3 Carbon Fiber Sandwich Repair Technique	35
4.4 Experimental Results of Carbon fiber sandwich Structures beam	37
4.5 Flexural stress calculations of Sandwich beams	40
4.6 Digital Image correlation Results	41
4.7 Outcome of the experiments	44
5. OTHER APPLICATIONS	47
5.1 Robotic Drilling in Complex Postures	47
5.2 Robotic Micro-drilling for orthopedic applications	49
6. CONCLUSIONS AND FUTURE WORK	51
6.1 Conclusion	51
6.2 Future Work	51
REFERENCES	53
VITA	60

LIST OF FIGURES

Figure	Page
1. 1 a) Robotic drilling in repetitive tasks, b) Manual drilling in non-repetitive tasks	2
1. 2 Human robot collaboration and drilling in Complex orientations	4
2. 1 Robots with different End-effectors for different applications	8
3. 1 Sawyer Robot live feed in <i>intera</i> software	16
3. 2 Sawyer Robot quick parameter changes in <i>Intera</i> software	17
3. 3 Attachment for Dremel Drill to be attached, a) Bottom view of Part 1, b) Side view of Part 1 with Steel blocks (c) Side view of Part 1 without Steel blocks inserted d) Drill attached to the Sawyer Robot Arm	19
3. 4 Part 2: Attachment for Part 1 that attaches to the Sawyer arm	19
3. 5 Kinesthetically teaching different positions	21
3. 6 Test carried out with different Δt , t_a^i = initial time of approach, t_a^f = final approach time, t_d^i = initial time of drilling, t_d^f = final time of drilling	22
3. 7 Sawyer Robot drilling with and without Human support	22
3. 8 Images of drilled holes with Robot only and with different time breaks. a) $\Delta t = 0$, b) $\Delta t = 3$ sec, c) $\Delta t = 30$ sec	23
3. 9 Images of drilled holes with Robot only and with different time breaks. a) $\Delta t = 0$, b) $\Delta t = 3$ sec, c) $\Delta t = 30$ sec	24
3. 10 Plot of average diameter of drilled holes with/without human	25
3. 11 Digital Microscope	26
3. 12 Sawyer Robot Dimensions	27
3. 13 Electro-plated multilayered diamond solid thin drill-bit	28
3. 14 Digital Microscopic image of drilled holes with $\varnothing 0.5$ mm drill-bit	29
3. 15 Average plot of drilled hole diameter with different force	31
4. 1 Sandwich Structure	32
4. 2 Vacuum bagging for making of Sandwich Structures	33
4. 3 Test setup (four-point bend test)	34
4. 4 Sandwich structured beams with different spacing between drilled holes,	35
4. 5 Epoxy Resin and Hardener	36
4. 6 Digital Microscope Images of the Sandwich Structured Sandwich beams cut in half	37

4. 7 Load Vs Displacement graphs of pair of samples with L, 2L & 3L spacing between the drilled holes. (L = 5mm)	39
4. 8 Shear force and Bending Moment Diagram	40
4. 9 Digital Image Correlation Setup for Analysis of Four Point Bend test	42
4. 10 DIC images of Carbon fiber sandwich panel four point bend test.....	43
4. 11 Larger span sandwich panels	44
4. 12 Larger span Sandwich panels with clear de-bond.....	45
5. 1 Sawyer Robot drilling in different orientations	48
5. 2 Sawyer Robot Drilling on Beef Bone, a) Sawyer Robot drilling, b) close look at drilling, c) Magnified image of drilled holes taken by digital microscope.....	50

LIST OF TABLES

Table	Page
Table 3. 1 Physical Properties of Vero-Blue Poly-jet material.....	18
Table 3. 2 Average Diameter of Drilled holes with/without Human.....	25
Table 3. 3 Robotic drilling with different force applied	30
Table 4. 1 Samples with max loads with different spacing (Pristine & Repaired).....	38
Table 4. 2 Flexural stress of pristine and repaired samples	41
Table 4. 3 Max Load and Flexural Stress of Larger Span Sandwich Structures	46

CHAPTER 1

INTRODUCTION

1.1 Motivation: Non-Repetitive, Micro-Drilling, Tasks

Drilling—a process of spinning a drill bit to cut a hole through a material—is a critical need in diverse fields ranging from advanced manufacturing to the medical industry. For example, drilling precedes riveting, which is used to fix most of the components in aircraft assembly. During this process, over 100,000 holes are needed in a small single engine aircraft and millions of holes are needed in a large transport aircraft [1]. Drilling tasks like these are repetitive and, therefore, are amenable for automation. Many robot manipulators have been deployed for such drilling tasks until now but are limited in their application as they: 1) can handle only repetitive drilling tasks, 2) require long hours of programming effort, and 3) are physically caged off from humans, operating in isolation, as they are heavy, involving large momentum during task execution, with no in-built safety mechanisms to share workspace with the humans.

As a result, manual drilling still prevails in many assembly, maintenance, repair, and surgical tasks, primarily owing to their non-repetitive nature, where the task parameters (e.g., material type and shape of the work piece to be drilled, number of holes, distance between holes, hole location and orientation) vary drastically from one task to the next. Manual drilling is also used in assembly processes involving high part complexity to be processed during the making of massive structures (e.g., floor grids, shells, and barrels) [54]. These manual drilling tasks are tedious, time consuming, and run the risk of rework and structural impairment, leading to additional costs.

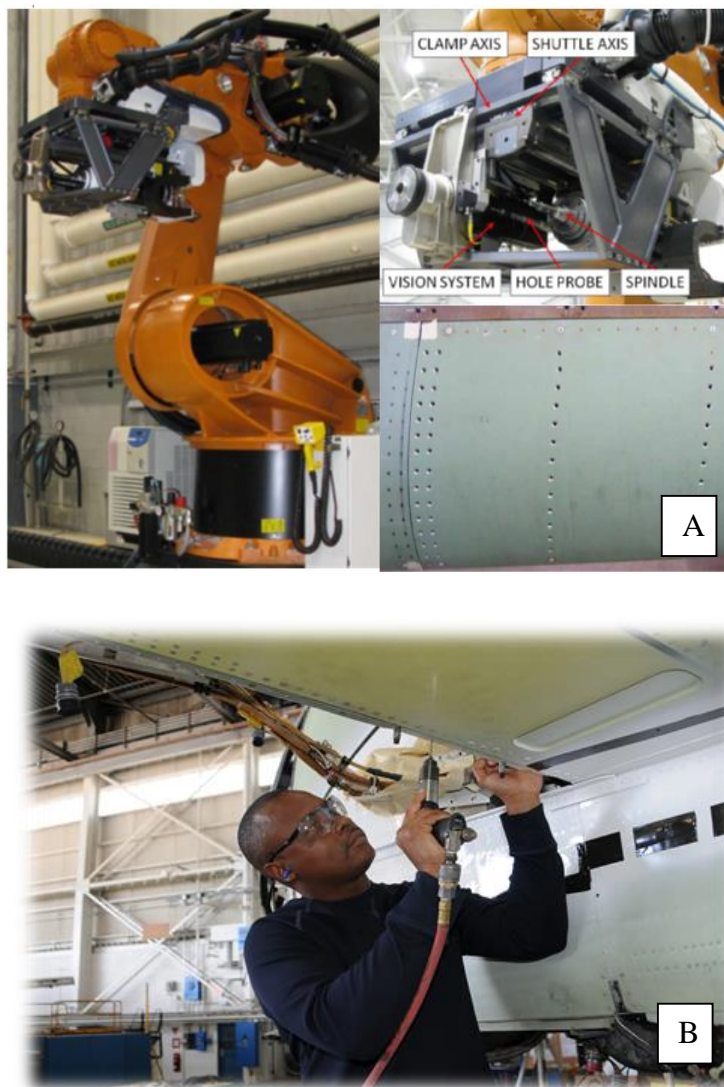

Fig. 1. 1 A) Robotic drilling in repetitive tasks [7],
 B) Manual drilling in non-repetitive tasks [56].

A class of drilling tasks (e.g., composite repairs, bone drilling, etc.) are not only non-repetitive but also require micro-drilling, typically involving drill-bits of diameters less than one mm. However, drilling micro holes manually is highly difficult as the drill-bits in this size range break very easily if the applied force is not controlled precisely. This leads to a design conflict as

there is a need to automate the micro-drilling task to overcome the problem described above, while its non-repetitive nature makes it difficult to do so.

1.2 Thesis Goals and Contributions

This thesis presents a robotic drilling methodology to address some of these deficiencies. The proposed design comprises features of human-robot collaboration and force-control to handle non-repetitive micro-drilling tasks, reduce the associated programming effort, and enhance drilling performance. Recent advances in low-cost, and human-safe, collaborative robots are enabling us to rethink the possibilities in which robots can be deployed for such non-repetitive, tedious, and time-consuming tasks. In particular, the Sawyer robot from Rethink Robotics, which offers safe physical interactions with a human co-worker, kinesthetic teaching, and force control, has been identified as the suitable candidate to implement these proposed features and is used as the test bed during experimental validation. The robot's end-effector was equipped with a Dremel drill fit into a housing, which was custom designed and 3D-printed using an Object Prime 3D-printer.

1.2.1 Human-Robot Collaboration

The proposed approach applies human-robot collaboration in two different contexts:

1. A human kinesthetically teaches a set of drill coordinates by physically holding the robot and guiding it to those locations. The robot then executes the drilling task by moving to these recorded locations. This avoids the need to specify the drill coordinates with respect to a fixed reference frame, leading to reduction in programming effort and setup time while transitioning between different drilling jobs.
2. Drilled hole quality has been shown to be enhanced when a human provides nominal physical support to the robot during certain drilling tasks.



Fig. 1. 2 Human robot collaboration and drilling in Complex orientations

1.2.2 Force-Controlled Micro-Drilling

An experimental analysis of the impact of force control on micro-drilling revealed that the proposed robotic system is capable of successfully drilling holes with a drill bit of 0.5 mm diameter with an error of ± 0.05 mm, without breaking it for more than 100 holes.

1.2.3 Targeted Application Domains

The proposed robotic drilling was first validated in the following application domain: Micro-drilling for composite repairs based on through-thickness reinforcement (TTR) technique. For this purpose, sandwich beam samples were prepared by using pre-preg unidirectional carbon fabric face sheets with a honeycomb core, and they were subjected to four-point static loading until debonding occurred between the face sheet and the core. The samples were then repaired using the TTR technique, where the proposed robotic drilling was used to drill holes of 0.75 mm diameter in the damaged area of the sample; carbon fiber rods and low-viscosity epoxy were manually inserted into these drilled holes. The results revealed that the sandwich beam regained effective compressive strength after going through the TTR technique. Experiments also reveal the potential of the proposed robotic drilling technique in aerospace and automotive manufacturing involving drilling in complex postures and micro-drilling for orthopedic applications.

Chapter 2

Related Work

A tremendous amount of work has been done in the field of Robotic drilling. Designs of different kinds of end-effectors for different kinds of robots with different functions including force control, speed control, etc. have been completed in industries from advanced manufacturing in aerospace and automobiles to the medical industry for carrying out surgical operations. A few researchers preferred to design their own end-effectors for robots based on their requirements and have achieved great success. Also, there is much recent research and advances in making low-cost, human-safe and collaborative robots which enables us to rethink the possibilities where robots can be deployed for tedious and time-consuming tasks currently done by humans or costly robots. There has always been a challenge in the field of micro-drilling which needs so much precision in force application.

Looking at some research and work done in the field of robotics, many robots need to be working in protected cells and not around humans for safety issues. Development in the field of human safe collaboration with robots is ongoing and taking great shape for future work. Nowadays, many robots come with human safety features and are designed to work in parallel with humans. We will be discussing some of the related work done in the field of robotic drilling, safe human robot collaboration, force-controlled robotic drilling, drilling performances, micro-drilling applications in the field of aerospace, automobile, medical, etc.

2.1 Robotic Drilling for Aerospace and Automotive Applications

Much research suggests that drilling can be a time-intensive and tedious job for humans to carry out. This is especially true in the aerospace and automobile fields where millions of holes are needed to be drilled to reduce the human load and also make the job efficient and more accurate. Assembly is the most time-consuming process in aircraft manufacturing, where automation provides more flexibility and reduces manual work and dedicated fixtures [15]. Nowadays, aircraft assembly lines, parts to be drilled (e.g., wing upper and lower covers, spars, ribs, fuselage, panels, etc.) are either drilled by means of a CNC machine or fixtures and jig and there is a need to automatize the drilling process in aircraft assembly lines by using anthropomorphic robots with low-cost and more flexibility [53]. The research activities and the industrial efforts were focused on the development of an all-in-one robotic drilling system. For example, Electro-impact developed a robotized drilling and end effector for Airbus UK Ltd. [2]. A robotic system, which uses orbital hole-drilling technology, was developed by Novator AB in collaboration with Boeing, to overcome the obstacles of drilling holes in a combination of both hard metals and composites [3].

The various stages of aircraft manufacture, repair, structural assembly, etc., are time-consuming, as pointed out by [4]. Also, there is a lot of research done in designing the end-effector for the drilling process, which is fully programmable and can realize different drilling modes [5]. Many drilling end-effectors for different robots have been designed and are successful in their tasks. Some of them are listed in the figure below.

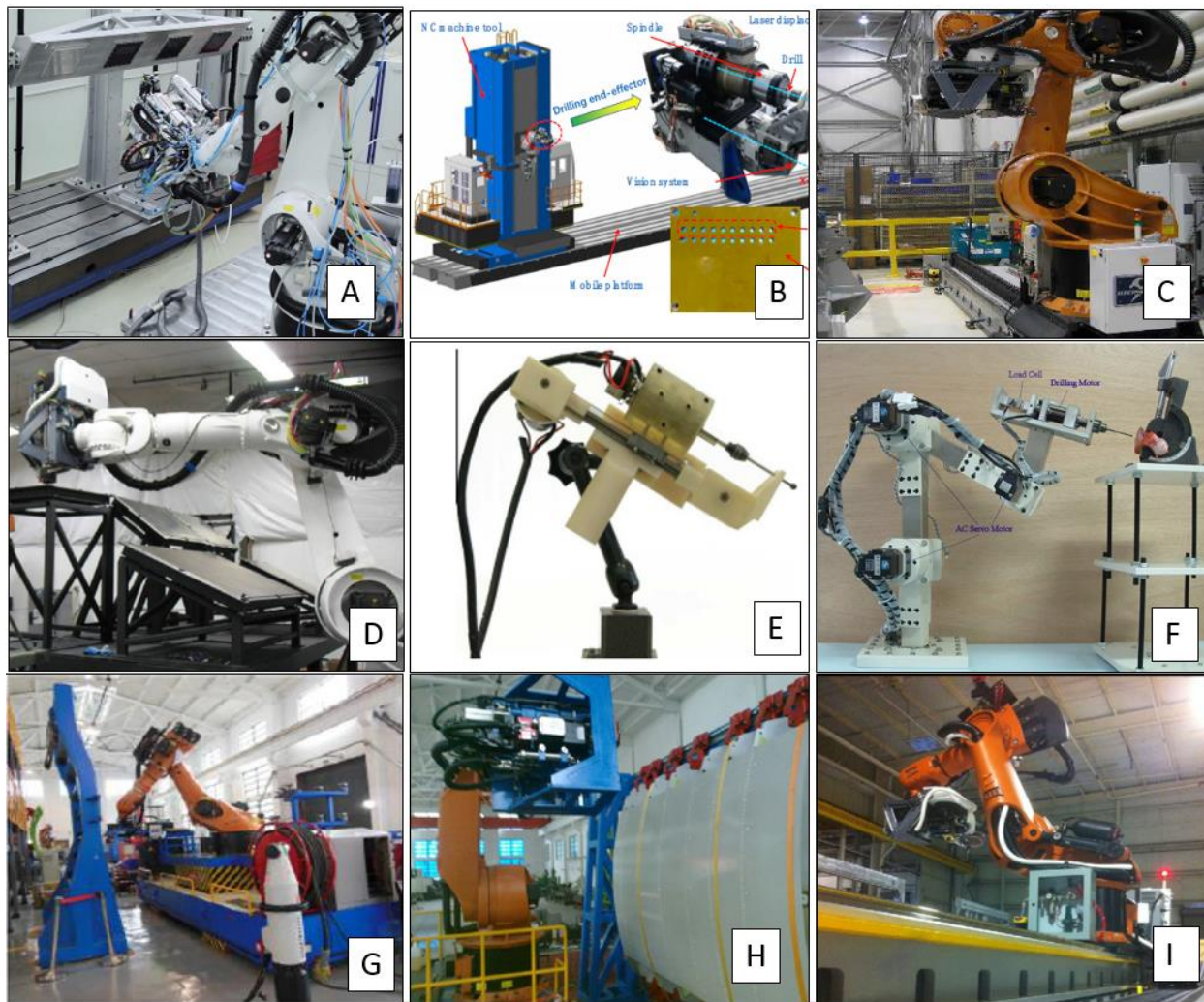

Fig. 2. 1 Robots with different End-effectors for different applications

A) Robotic drilling and riveting cell [6], B) Machine-tool based automated drilling system [10], C) Positioning system-robot and tract [7], D) Positional accuracy and process capability [9], E) Bone drilling guide and tool [12], F) three-axis robotic bone drilling system [11], G) Movable Robotic drilling system with air cushion [14], H) Robotic drilling system [13], I) Accurate Robot system [8].

2.2 Robotic Drilling for Medical Applications

There are many advances in the field of medical surgeries. Bone –drilling is an essential part in orthopedics, traumatology, and bone biopsy [23]. Drilling is also essential in dental surgeries and in recent years, according to the research, oral surgery involving dental implants has become more common. However, the risky drilling process causes serious accidents [24]. Robots for carrying out automated or semi-automated surgery are used in a wide variety of applications for carrying out operations in the medical field. Some robots are handheld devices and some are automated which requires a high amount of accuracy in completion of any task for surgery. Some work done in this field demonstrates that a high degree of coordination is required by surgeons to ensure safe and precise surgery while working with a device or a robot [16]. This paper showed a development of a system capable of predicting drilling faults and automatic drill control.

More safety is to be ensured while carrying out surgeries as it is reported that the rate of surgical complications is high and especially in some of the surgeries in otology the rate is about 2-6% where drilling is done near facial nerves, the sigmoid sinus, the semicircular canal, the cochlea or dura, [17,18]. Cochlear implantation has become the standard treatment for severe to profoundly deaf patients and requires precise drilling [20].

Robotic bone drilling is very useful in orthopedic surgeries. Many bone drilling systems are developed which focus on force control, drill-feed actuation, drill diameter, point angle, drilling speed and feed rate [19]. The necessary feature for bone drilling is force to be applied while drilling; otherwise, the drill bit can jam or even break in the bone [21]. Bone drilling procedures are frequently performed in various surgical fields using computed tomography. The robotic

systems employed to perform such procedures can improve the targeting accuracy and reduce radiation exposure to surgeons [22].

2.3 Force Control for Robotic Drilling

Robotic Control of the drilling process dates back to the 1980s and much research has been done and is ongoing in this topic [27-30]. Although drilling is the basic process in machining for basic metal cutting processes, critical analysis is needed while drilling and investigation of interactions between manual drills fixed to the end effector of the manipulator or robot and a workpiece [25]. A correct feed-rate with a controlled force is needed to drill a hole in any workpiece [26]. There are many advances in force control while drilling with a fixed support but it has always been a challenge to drill using an anthropomorphic robot which has many degrees of freedom.

Robotic drilling must be very organized in a way that it is widely used in the field of aerospace for composite repair, medical surgeries, etc. where an accurate amount of force is required. Many traditional robots were equipped with a load cell or force sensor in their end-effector [31] which made systems heavy and bulky. Using similar systems, it is possible to carry out accurate force control, but this prevents drilling in areas where huge and bulky end-effectors cannot enter and the task becomes way more difficult to carry out.

2.4 Drilling Performance Metrics

Drilling to be carried out where precision is required needs to have a very close tolerances, and use of special drill-bits is required. Drilling performance is dependent on spindle speed, feed rate, force control, drill-bits, and point geometry variation [32]. Tolerance and the hole accuracy needed depends on an application's requirement going from advanced manufacturing to medical surgeries.

Many studies show that the spindle speed and feed rate have a great effect on the hole quality and thrust force [5].

Aluminum, titanium and composite materials are widely used in the aircraft industry because of their high strength-to-weight ratio and stiffness-to-weight ratio. Many experimental studies investigated how the cutting parameters, tool materials, and coating, and cooling affect the hole quality and thrust force [33-35].

Many experiments are also carried out in the field of drilling bones and the parameters affecting the drilled hole quality. Most of the reviews are done on the basis of drill-bit geometry, drill-bit size, operating conditions, and material evacuation. Also analysis is being done on bone-drilling performance to fix the mechanical and thermal effects [36].

2.5 Micro-Drilling

Micro-hole drilling (holes less than 0.5 mm in diameter) is gaining increased attention in a wide spectrum of precision production industries [37]. Until now, there has been many methods accepted, tested and adopted for experimentation with micro-drills, but mechanical drilling is widely used as it is more independent of workpiece properties and is less subjected to thermal deformation. Special care needs to be taken while experimenting with micro-bits, as force increases after it penetrates into the workpiece and there are more chances for a drill-bit to break. Thus, force control in micro-drilling is required with full control over feed rate.

With manual drilling it can be impossible to get perfect accuracy, alignment or the quality of the holes for micro-holes. Many advances in the field of robotic drilling are made but very few are with micro-hole robotic drilling. Research is ongoing in the field of robotic micro-drilling to

control drill-bit breakthrough during low-speed micro-drilling. Not only in the field of aerospace but also for certain medical surgeries, there is a need for low-speed micro-drilling for flexible bone elements [38].

2.6 Human-Robot Collaboration

The use of robots in factories is limited by the robots' ability to safely collaborate with one another and with human workers [39]. So much research has been done that suggests that Human Robot Collaboration makes the job more efficient, making minor adjustments, and developing a semi-automated system. One solution for the flexible and skill-based automation processes is represented in Human-Robot-Collaboration (HRC) for the assembly of high-quality machines for the medical industry. Instead of an inflexible, fully automated approach, a semi-automated method is being developed that can be easily controlled by an operator on the shop floor [40].

HRC robot systems not only provide the quick setup of a robot cell but also intuitive operation concepts which allow simplified use of the robot with little to no specialist knowledge. This enables the operator to create or adjust robot applications directly on the shop floor in a short amount of time. An example of this includes the direct adjustment of a path through manual guidance of the robot's kinematics or gesture-controlled programming [41]. Another excellent example of Human Robot Collaboration is the research carried out by Gil Boyé de Sousa [42], 3D metrology using a collaborative robot with a laser triangulation sensor. Industrial robots are a key element in Smart Manufacturing systems. They can perform many different tasks such as assembly, pick-and-place, or even 3D metrology operations.

There are some of the experiments and methods also developed where there is no need for physical contact between robot and human or between robot and environment. The human workload is

reduced, diminishing the risk of strain injuries. Besides, a complete risk analysis is done and it is proposed that setup is compatible with safety standards. The robot alternates active and passive behaviors during assembly to lighten the burden on the operator in the first case and to comply with his/her needs in the latter [43]. All the research and analysis shows that HRC can be time-effective, safe and more efficient when carried out compared to robots just working in the closed cell or just humans working on a particular task.

2.7 Composite Repair

Due to its low density, high thermal conductivity and excellent mechanical properties at elevated temperatures, composite material is an ideal material for use in aircraft [44], especially Sandwich structures in composites are more desirable as they provide high bending stiffness with overall low density. With the increasing use of composites, there is also increasing research for its defects and how to repair composites to overcome those defects. It is more desirable to repair any part than to replace it, taking care that composites are expensive. We are following the work of Byron Pipes who has contributed much to this field. One of his works, ‘Compressive strength of composite laminates with inter-laminar defects,’ suggests that the compressive strength of a composite laminate is greatly reduced by the local instabilities initiated by inter-laminar defects [45]. The study suggests a way of overcoming inter-laminar defects that occur in the composites.

Impact damage can degrade the flexural strength of composite sandwich structures by over 50% due to a loss of skin support that induces localized skin buckling [46]. Some self-healing techniques are developed which use a healing agent. Repair techniques like smart repair of delaminations in polymer composites, which uses compression strength after impact tests as a measure of the effectiveness of repair technique, are developed [47].

There are many techniques developed to overcome such defects in composite sandwich structures. In this thesis, we will be using '*through thickness reinforcement*' for carrying out the repair of defects in sandwich structures. During the repair, it is necessary to drill micro-holes which will be achieved by using the Robotic drilling.

CHAPTER 3

ROBOTIC DRILLING METHODOLOGY

3.1 Goals

This thesis presents a robotic drilling methodology with features of force-control enabled micro-drilling and Human-Robot Collaboration to reduce programming effort and enhance drilling performance. The robot will be able to drill micro-drills as small as 0.5 mm diameter with a controlled force while drilling and controlled speed of approach for the drilling position. With a very bulky drilling housing that incorporates the force feed-back control, and other systems, it is very difficult for a robot to drill in tight places. Also, due to lack of maneuverability and fixed robots, the task becomes tedious and time-consuming to set the workpiece in place for the robot to drill. The goal is to develop a safe human robot collaborative environment where a human and robot work on the same task making it more efficient without any work cells or fencing provided. This thesis conducts experiments on how human robot collaboration can be more effective than human only, which also saves time for programming. The feature in the Sawyer robot '*Learn by Demonstration*' is used for kinesthetically teaching the trajectory for the task to be done and shows that it can be the best replacement for non-repetitive tasks where every-time parameters need to be changed. Also the demonstration of micro-hole robotic drilling will be presented which depicts the use of very small diameter drill-bits for repairing composites and some medical applications, where very small holes are needed.

3.2 Sawyer Robot from Rethink Robotics

A Sawyer robot from Rethink Robotics, which offers capabilities of safe physical interaction with a human co-worker, kinesthetic teaching, and force control, is used as the test bed. The Sawyer

Robot by Rethink Robotics was used for carrying out the Semi-Automated Robotic drilling process, where a human kinesthetically taught the coordinates to the robot and the Sawyer robot was able to record those coordinates, while also remembering the trajectory of the path that was followed by the human. The Sawyer gave the live feed of all the motions that it goes through via *Intera* software. Also, it enables us to change parameters like force, speed control for approaching to the position of task, changes in the coordinates in increment of 0.1 mm, etc. The robot has different speeds of working which includes slow, medium, fast and express. It has also has an advanced speed mode with settings like max translational speed, max translational acceleration, max rotational speed, and max rotational acceleration. For drilling to be carried out with drill-bits as small as 0.5 mm, it was necessary to apply very little force on the workpiece. The Sawyer robot was able to control speed while drilling with an increment of 0.1 N and ranging from 0.1 N to 50N. In industrial drilling, speed for approaching the workpiece, should be a maintained when drilling in multiple positions and orientations, which was very well served by the sawyer robot. The programming of the robot was made easy using the kinesthetic teaching and *Intera* software provided by Rethink Robotics.

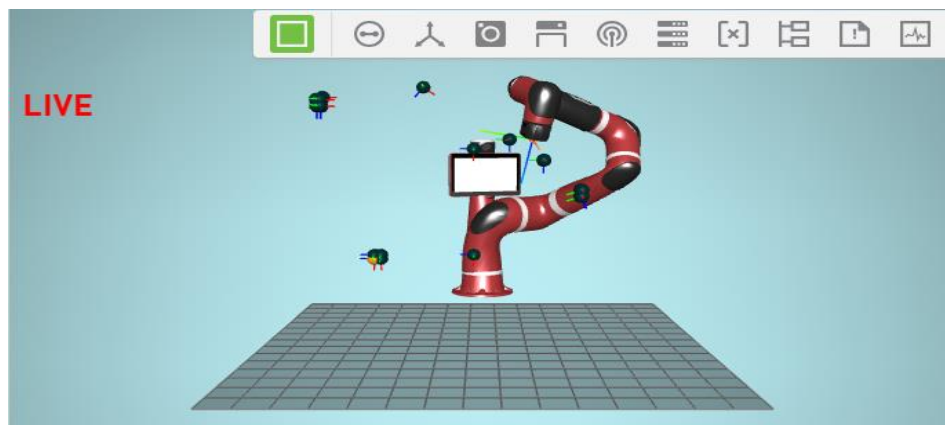

Fig. 3. 1 Sawyer Robot live feed in *intera* software

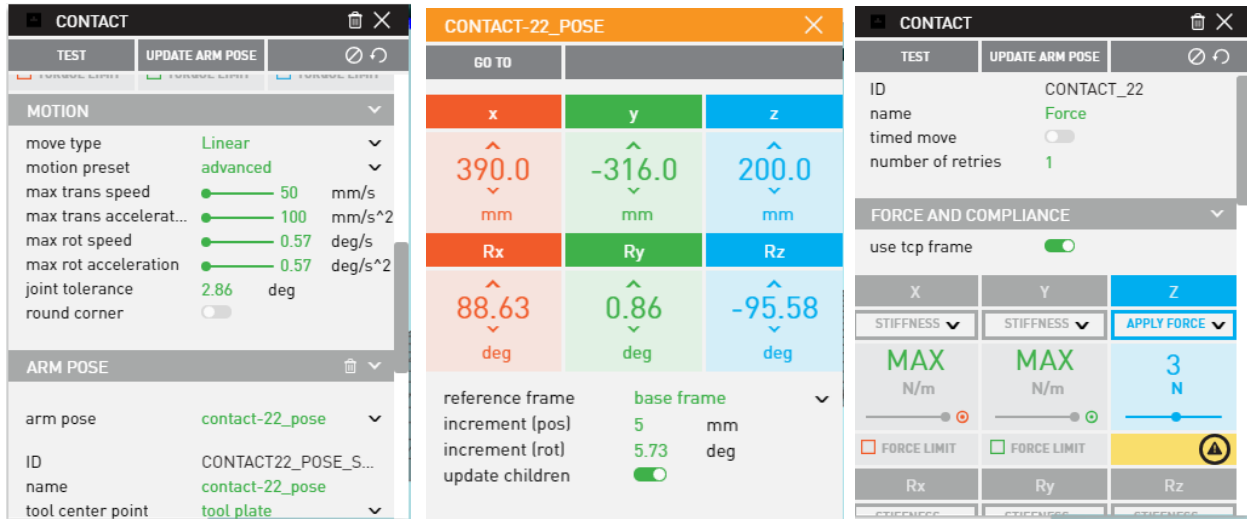

Fig. 3. 2 Sawyer Robot quick parameter changes in *Intera* software

3.3 Drill Housing Design

The robot's end-effector was equipped with a Dremel drill fit into a housing, which was custom designed as it only comes with pick and place gripper and drilling is not the primary purpose of the Sawyer robot. For a drill to be attached to the Robotic arm, it was necessary to design the attachment according to the drilling machine. The drill used here for drilling holes on composite material was a Dremel 200-N/15 0.9 Amp 2-Speed, which can be used to drill holes with very small diameters. The Solid-works designing software was used to design the attachment. A Stratasys Objet3D printer was used to 3D print the attachment. The material used for 3D printing the attachment was Vero-Blue Poly-jet material [49] having properties as shown in Table 3.1.

Physical Property	Metric	Unit
Tensile Strength	7250-8700	psi
Elongation at break	15-25	%
Modulus of elasticity	2000-3000	Psi
Hardness	83-86	(Shore D)
Heat Deflection @ 264 psi	113-122	°F
Flexural Modulus	1900-2500	MPa

Table 3. 1 Physical Properties of Vero-Blue Poly-jet material

The attachment was designed in 2 parts; 1 part attaches with the Dremel drill and the other part attaches to the end of the Robotic arm. It was designed in such a way that the Dremel drill should have a very tight fit so that there are no vibrations due to the attachment during the process of drilling. To ensure a tight fit, there was a feature in the design where 4 small blocks of Stainless Steel with a thread for a screw, were inserted into the 4 small cavities in the attachment as shown in Fig. 3.3. Also, screws with threading were fastened through steel blocks and the attachment to touch the body of the Dremel drill making it a very tight fit to the attachment. The total mass of the attachment including the drill was ~680 grams.



Fig. 3. 3 Attachment for Dremel Drill to be attached, a) Bottom view of Part 1, b) Side view of Part 1 with Steel blocks (c) Side view of Part 1 without Steel blocks inserted d) Drill attached to the Sawyer Robot Arm

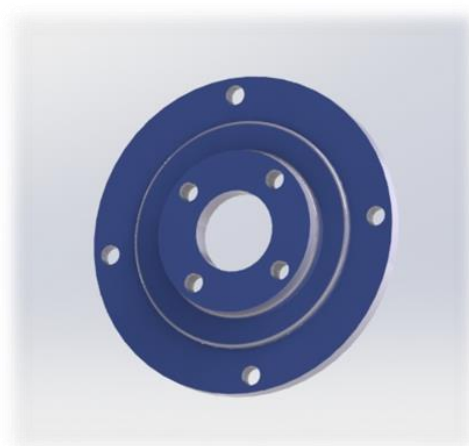

Fig. 3. 4 Part 2: Attachment for Part 1 that attaches to the Sawyer arm

3.4 Human Robot Collaboration Strategies

The proposed approach applies human-robot collaboration in two cases. First, a human kinesthetically teaches a set of drill coordinates by physically holding the robot and guiding it to those locations. The robot then executes the drilling task by moving to these recorded locations. This thereby avoids the need to specify the drill coordinates with respect to a fixed reference frame, leading to reduction in programming effort and setup time while transitioning between different drilling jobs.

During a complex positioning system, it takes hours to program a fancy robot, which can be reduced by using a sawyer robot with human collaboration. Also, due to the low weight and not providing a bulky end-effector it can go over tight places and drilling can be accomplished with the required amount of force which may or may not be possible for a human to complete the task using a manual drill. Second, drilled hole quality is shown to be enhanced when a human provides nominal physical support to the robot during certain drilling tasks.

3.4.1 Kinesthetic Teaching of Drill Coordinates

The Sawyer robot has a feature which enables motion of the robotic arm at ease with just the click of a button. A robotic arm can be taken to the desired drilling position and can carry out the drilling process easily with changes in the parameters using *intera* software. Some of the pictures of training the sawyer robot arm can be seen below.

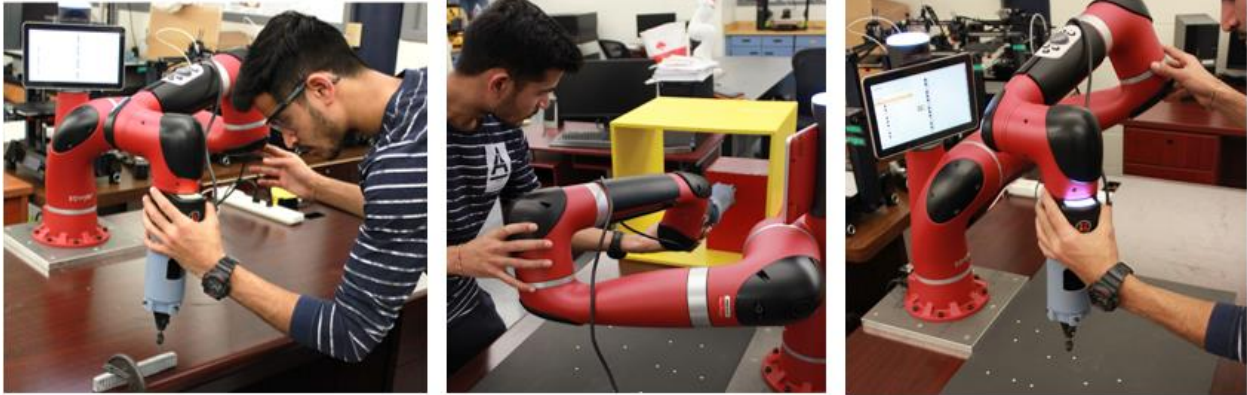

Fig. 3. 5 Kinesthetically teaching different positions

3.4.2 Human support during drilling

Robotic drilling was carried out as a Human-Robot Collaborative task. To distinguish between the results of drilling without humans and with a human, we carried out an experiment in which there was a set of holes drilled with the Robot only and there was a set of holes which were drilled with the help of a human during alignment. The human did not give any force while the experiment with the human was carried out. A very light support before actual drilling was given for the perfect alignment of the drill-bit and the specimen. The experiment was carried out with different time breaks between the approach to the point of drilling and touching the surface to start drilling. It can be clearly understood from Figure 19, which shows Δt to be the difference in time from the initial time of drilling and the final time of approach for drilling.

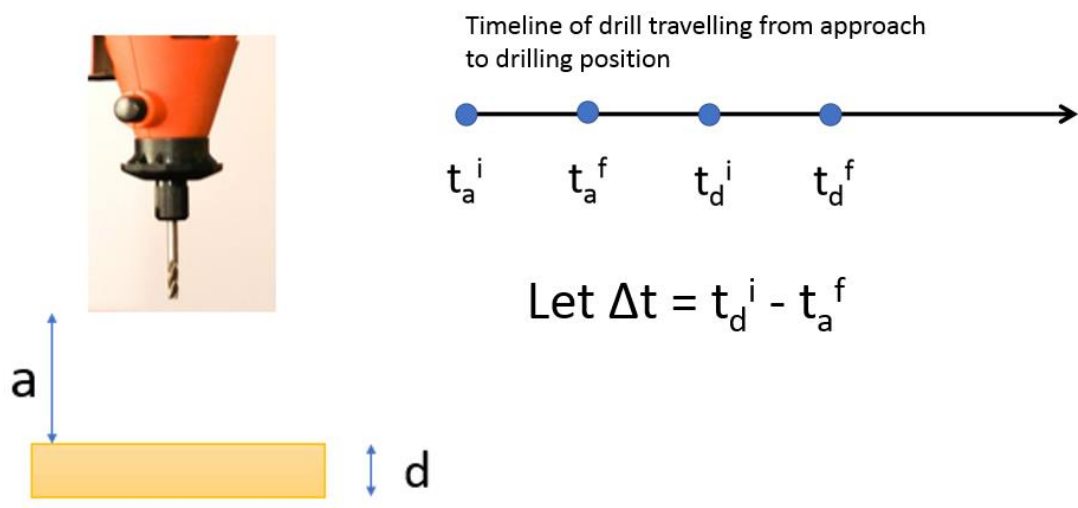

Fig. 3. 6 Test carried out with different Δt , t_a^i = initial time of approach, t_a^f = final approach time, t_d^i = initial time of drilling, t_d^f = final time of drilling

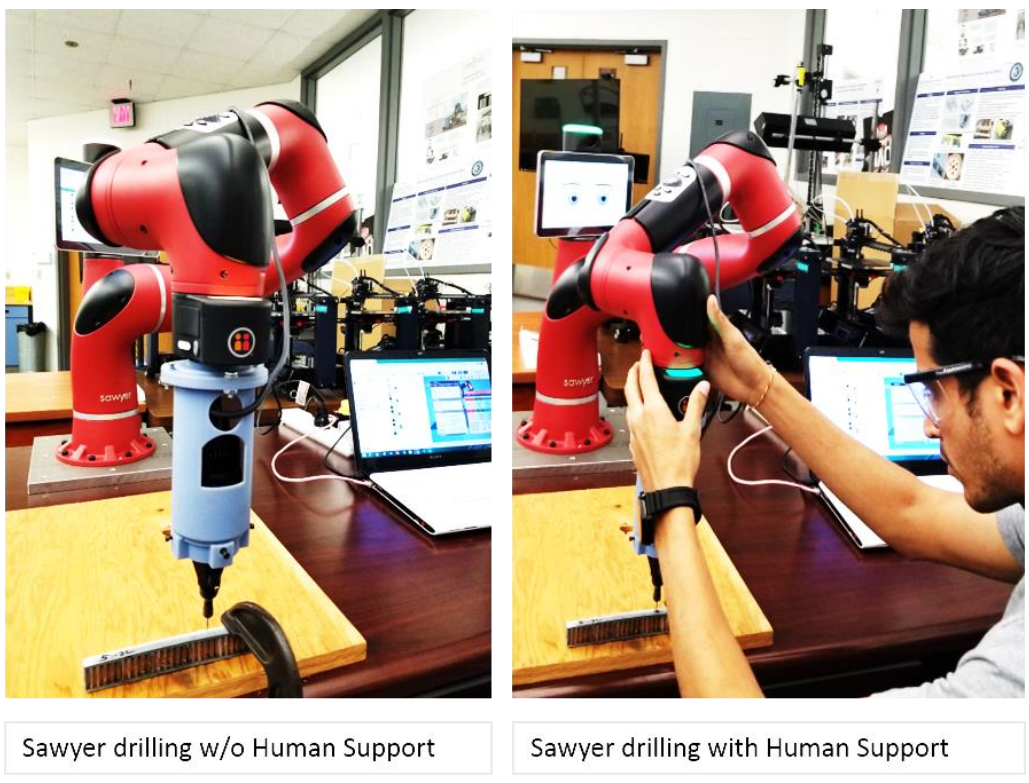

Fig. 3. 7 Sawyer Robot drilling with and without Human support

The experiment was carried out in a way considering 3 cases: case 1, when $\Delta t = 0$, case 2, when $\Delta t \neq 0$, but Δt is very small, say 2 or 3 sec and case 3, when $\Delta t \neq 0$, but Δt is very large like 30 sec. The material used for carrying out the experiment was wood. Wood was chosen to get more accurate results, wood being a softer material than others. The drill-bit size used was 1.5 mm with a Dremel 200 drill at a speed of 15,000 rpm. The force applied by the Robotic arm to drill holes was 3N. The experiment was carried out to check on the force feature, task repeatability, tool speed, etc. that makes the Sawyer Robot more suitable for drilling harder materials.

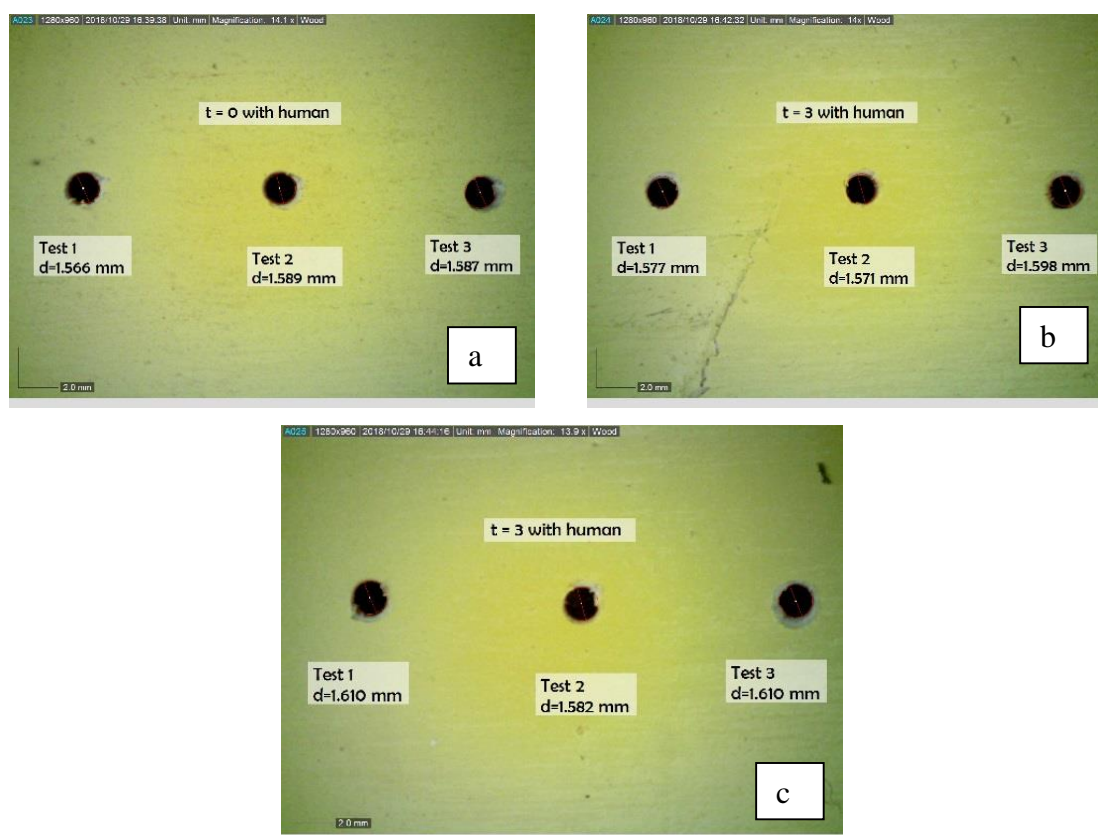

Fig. 3. 8 Images of drilled holes with Robot only and with different time breaks. a) $\Delta t = 0$, b) $\Delta t = 3$ sec, c) $\Delta t = 30$ sec

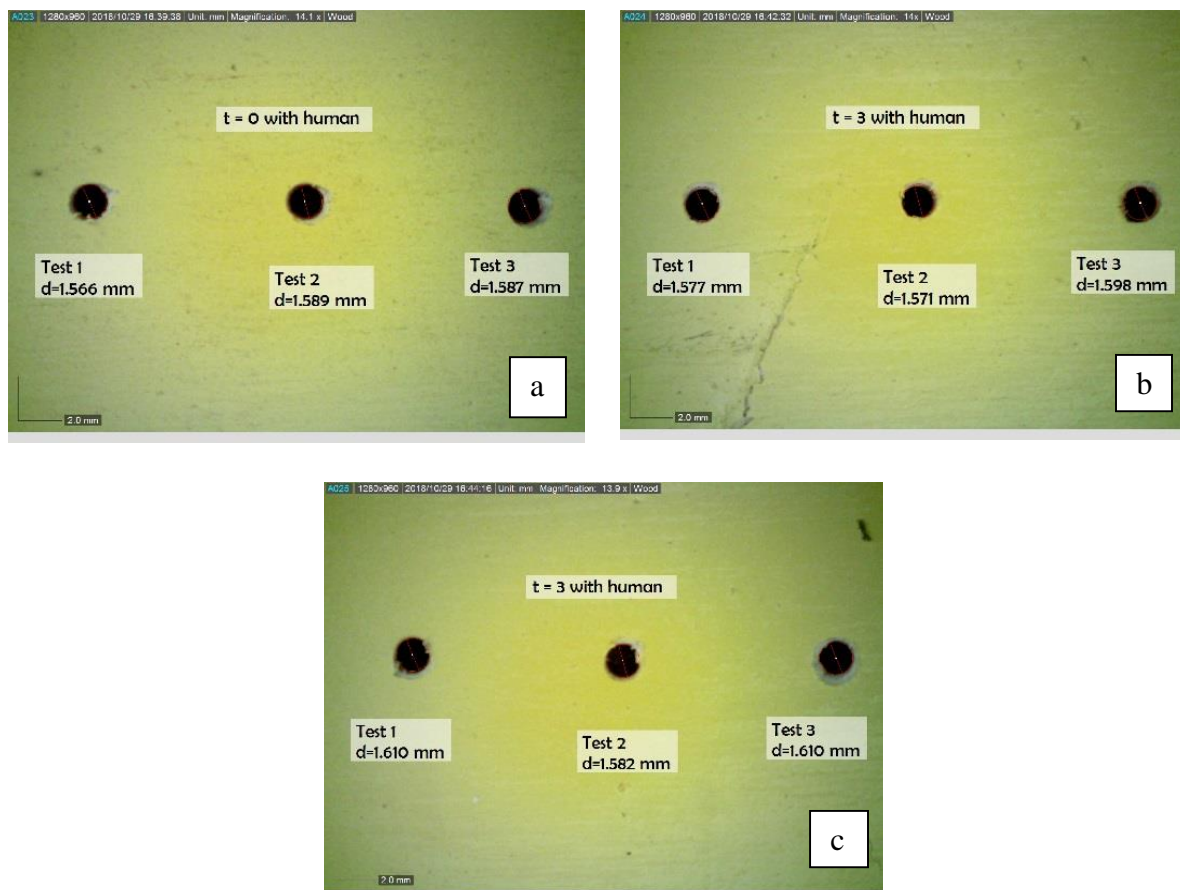

Fig. 3. 9 Images of drilled holes with Robot only and with different time breaks. a) $\Delta t = 0$, b) $\Delta t = 3$ sec, c) $\Delta t = 30$ sec

Table 3. 2 Average Diameter of Drilled holes with/without Human

Case	Average diameter of drilled holes(mm)	
	Without human	With human
$\Delta t = 0$	1.625	1.581
$\Delta t = 3 \text{ sec}$	1.686	1.582
$\Delta t = 30 \text{ sec}$	1.657	1.601
Std. dev	0.03	0.01

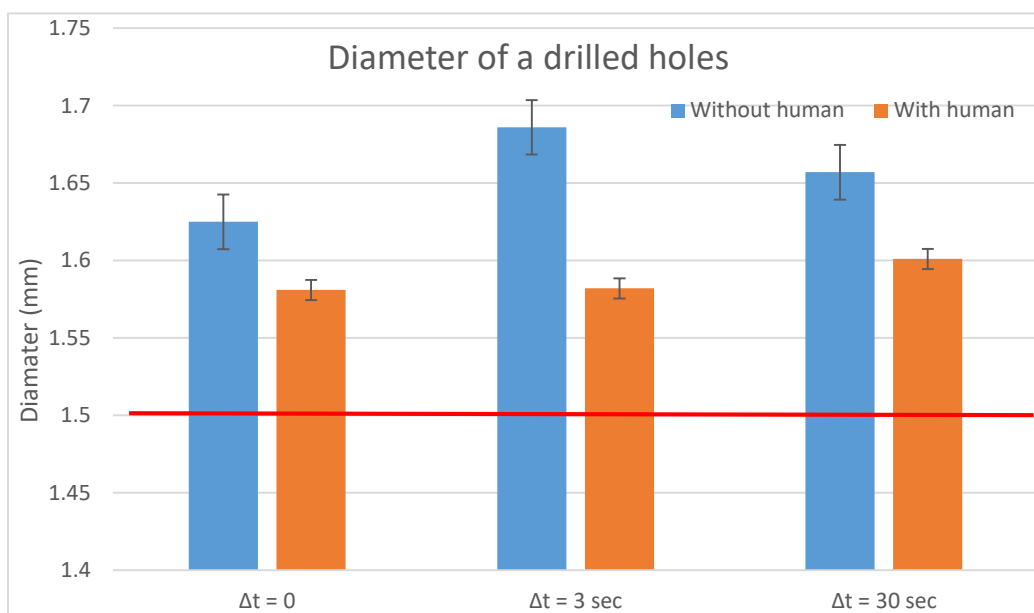

Fig. 3. 10 Plot of average diameter of drilled holes with/without human

For analysis to be carried out drill quality and diameter of drilled holes, dino-lite digital microscope AM73115MTF was used. It comes with a calibration panel and magnification rate up to 70x, which helps in better quality and measurements of small profiles

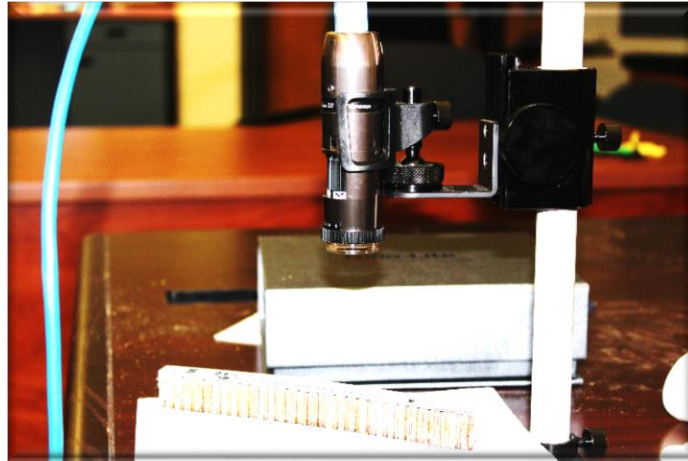

Fig. 3. 11 Digital Microscope

After analysis of all the data and images taken by digital microscope, it can be clearly said that there was a better alignment of the drilled holes with a human and that the quality of the holes by diameter also increased when drilled with the help of a human. The average of the diameters measured with the help of a microscope as shown in Figures 20 and 21, showed that it was able to produce good results in both cases but was able to get slightly more accurate results in Human Robot Collaboration than in the Robot only experiments.

3.5 Force control for Robotic Micro-drilling

Micro-drills are not like conventional drills that come with flutes, commonly known as a ‘twisted drill’. Instead, micro-drills are either solid thin drills or a spade type because of the difficulty in fabricating a twist drill of this size [49]. Robotic drilling has always been a challenge. Much research has been done in Robotic drilling, but it has some or the other disadvantages. One of the main disadvantages in robotic drilling is stiffness and poor positioning accuracy [50], but our approach with the Sawyer Robot overcomes this disadvantage, having high stiffness in all the directions with the very-good positional accuracy of $\pm 0.1\text{mm}$. The Sawyer Robot has 7° of freedom with a 1260mm maximum reach. It can maneuver into tight spaces and around fixtures and doors much like a human arm and sometimes in places where humans find it difficult to reach or complete atask.

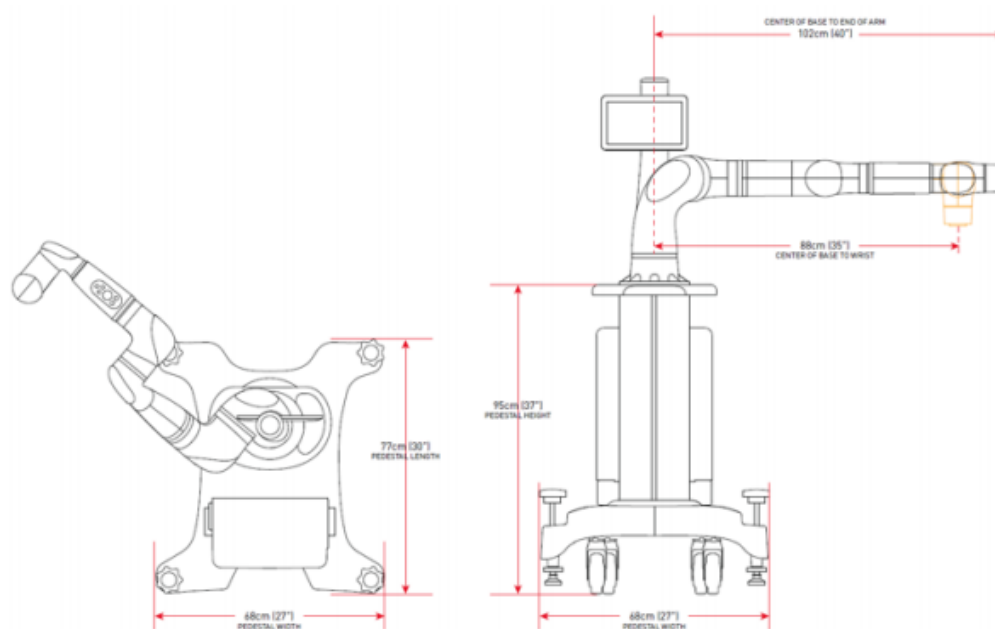

Fig. 3. 12 Sawyer Robot Dimensions [51]

The experiments were carried out with small drills ranging from 0.5 to 5mm. The smallest successful drill-bit size we were able to drill with was 0.5mm which was very small and can break even with a very minute force applied to it. The experiments consisted of different drill-bits, with different force applied according to the need of a material. The validation of the drill quality and check for diameter was done using a digital microscope.

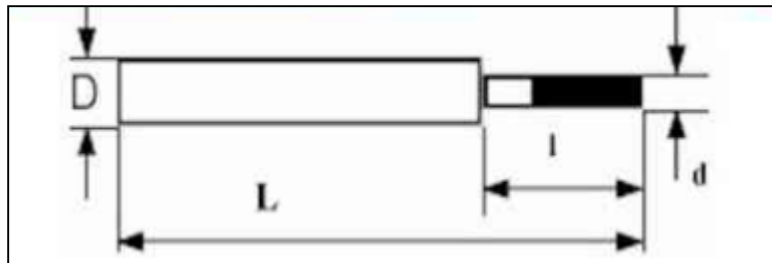

Fig. 3. 13 Electro-plated multilayered diamond solid thin drill-bit

The experiment for the smallest successful drill-bit (i.e. 0.5mm) was carried out on Hexcel IM7 8552 unidirectional carbon fiber. It is a continuous, high performance, high tensile strength, intermediate modulus, PAN based fiber available [31]. The drill-bit used here was multilayered electroplated diamond solid drills-flat bottom cylinder, where the drill-bit length was 45mm, head length was 15mm and drill-bit diameter was 0.75mm. The drill used for the experiment was a Dremel 200N, at a speed of 15,000 rpm.

The drilled holes were then measured using a digital microscope and it was found that there was less than ± 0.05 error in the diameter of the actual drill-bit size and measured drilled holes diameter.

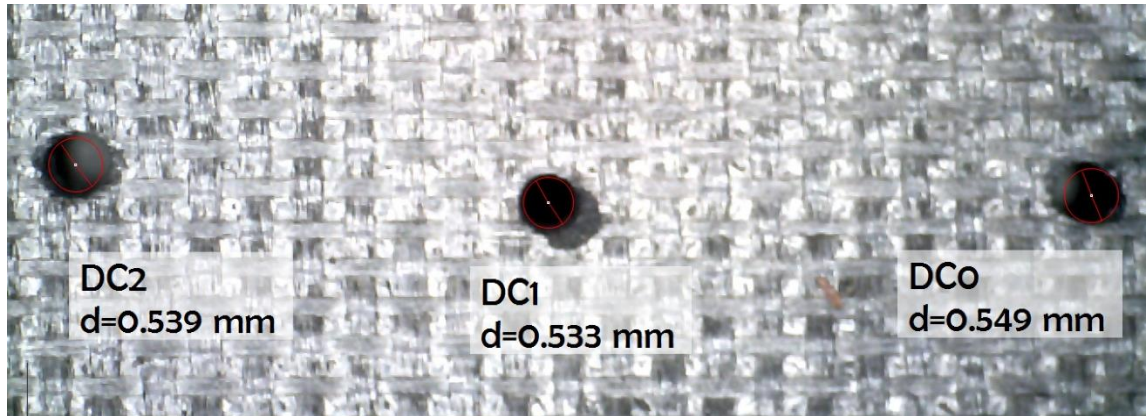

Fig. 3. 14 Digital Microscopic image of drilled holes with \varnothing 0.5mm drill-bit.

Further experiments were done with a 0.75 mm diameter drill-bit. The robot can be programmed for any task using the Intera Software offered by Rethink Robotics for any field in manufacturing, automation and quality engineering. The aspects of built-in force sensing capabilities allow it to make adaptive decisions as tasks run, enabling the Sawyer Robot to work precisely (\pm .1 mm), while operating safely next to people [51]. Also, the feature that allows us to change the parameters between each move of the task in Intera Software makes the task more efficient and time saving. It has different speeds of operating as slow, medium, fast, and express. It also has a speed mode called advanced in which we can change the max translational speed, max translational acceleration, etc. We carried out the drilling operation on industrial grade composite Hexcel IM7 8552 unidirectional carbon fiber with a thickness of 5 mm approx., with a different amount of force (4N, 5N & 6N) respectively.

Table 3. 3 Robotic drilling with different force applied

	Test	4N	5N	6N
Diameter (mm)	1	0.822	0.77	0.766
	2	0.767	0.771	0.783
	3	0.764	0.768	0.771
	4	0.767	0.753	0.843
	5	0.789	0.77	0.761
	6	0.776	0.771	0.801
	7	0.762	0.768	0.756
	8	0.765	0.753	0.783
	9	0.831	0.77	0.759
	10	0.788	0.771	0.825
	11	0.785	0.768	0.776
	12	0.807	0.753	0.807
Average		0.79	0.77	0.79
Std. Dev.		0.02	0.01	0.03

The experiment began with drilling holes at 0.5 N force application. We found that it was not enough force to drill a through hole, so it was followed by 1 N, 2 N & 3 N. Also, excessive force, like more than 6 N, resulted in the breakage of the drill-bit. Later, we carried out an experiment to check if there was any difference in drilled hole quality and diameter of drilled holes. In all the cases with different force application, it was found that there was not much difference in the quality and diameter of the drilled holes. The drilled holes were examined and measured using the digital microscope. We can also see that there was not much difference in average of the diameters of holes taken after each kind of test from the graph below followed by standard deviation.

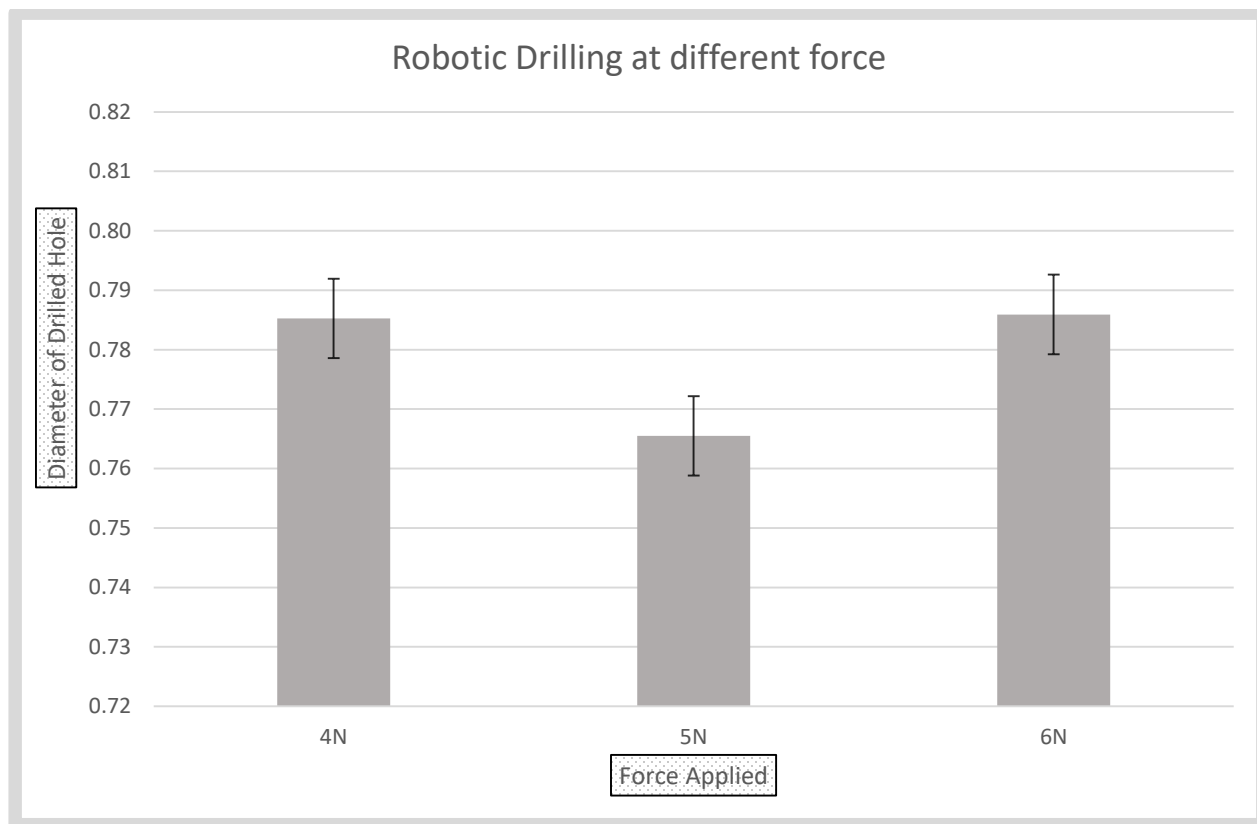

Fig. 3. 15 Average plot of drilled hole diameter with different force

CHAPTER 4

COMPOSITE REPAIR USING THROUGH THICKNESS REINFORCEMENT (TTR) TECHNIQUE

4.1 Design and making of Sandwich Beams

Our design approach is based on a sandwich (food item) which consists of one or more types of food, such as vegetables, slices of meat or cheese, placed on or between slices of bread. The simplest structural sandwich is a three layered construction formed by bonding a thin layer (face sheet) to each side of a thick layer (core). It provides high bending stiffness with overall low density.

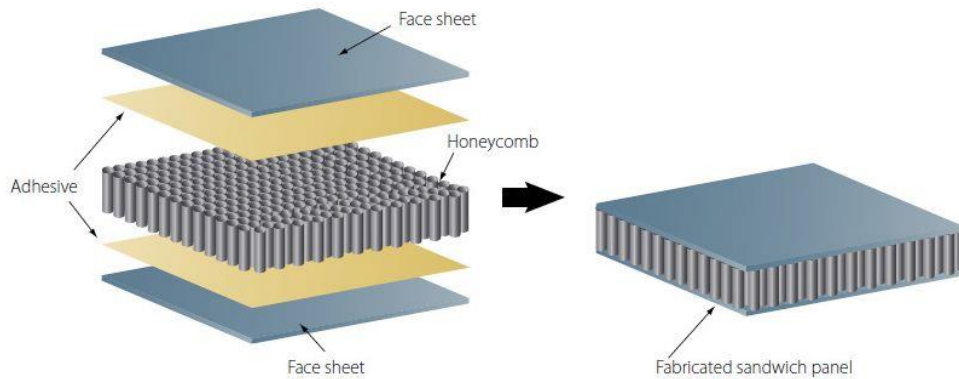

Fig. 4. 1 Sandwich Structure [55]

As shown above, there are layers of adhesive that are placed in between the face sheets and honeycomb core for a strong bond between the core and face sheet. In this thesis, we have not used adhesive layers to get better results of de-bonding between face sheets and honeycomb core and better understand the strength of the repaired samples.

The sandwich beams were designed in a way that there were 8 plies of $[0/90_2/0]_s$ unidirectional pre-preg carbon fabric face sheets 180 mm (length) and 150 mm (width) on each side of Nomex Core Honeycomb Aramid fiber of height 3/4". The vacuum bagging method was used to process and cure the sandwich panels. The component should be cured as a single shot process, and the necessary consolidation is obtained using a vacuum. This can be cured in an oven, and additional pressure can be applied if an autoclave is used. This method is suitable for items with pre-preg or preformed composite or metallic facing skins. When a flexible or formed honeycomb core and film adhesives are used complex items may be produced as in this thesis.

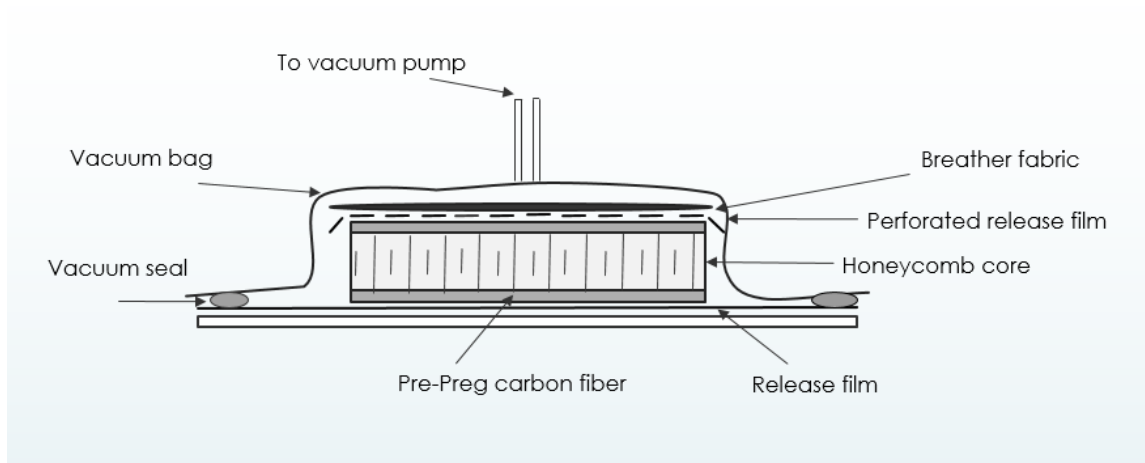

Fig. 4. 2 Vacuum bagging for making of Sandwich Structures

The sample is then placed in a heating oven at about 160°C for about 6-8 hours with the vacuum pump kept ON. The sample manufactured was then available to cut into pieces and the process was completed using a ProtoMAX Waterjet to get the finest quality cut.

4.2 Test setup for four-point bend test

The compression test of the Sandwich structured beams were carried out using four point static loading. The test setup was set in such a way that the top rollers of the four point bending setup have enough space in between them to make sure enough de-bond is generated between the top face-sheet and the honeycomb core in middle. The size of the samples was approximately 180×13×25 mm (Length × thickness × width). Thus, the spacing between the top roller and bottom rollers in a four point bending test was kept as 160 mm and 40 mm respectively.



Fig. 4. 3 Test setup (four-point bend test)

4.3 Carbon Fiber Sandwich Repair Technique

The repair technique that we used for repair of the honeycomb sandwich structured specimens was ‘through thickness reinforcement’. As discussed earlier, the manufactured composite sandwich panel was cut into 6 samples of 1/2" width approximately. All pristine samples were tested for flexural stress at the max load applied. Also, two samples each were drilled with a distance of L , $2L$ and $3L$ between the drilled holes respectively after being damaged, where $L= 5$ mm. The holes were drilled with the help of Human robot Collaboration with the Sawyer Robot. The drill-bit used for drilling was a multi layered Electroplated Diamond Solid thin drill of $\varnothing 0.75$ mm with a max operating speed of 30,000 rpm, with head length 15 mm and drill length 45 mm.

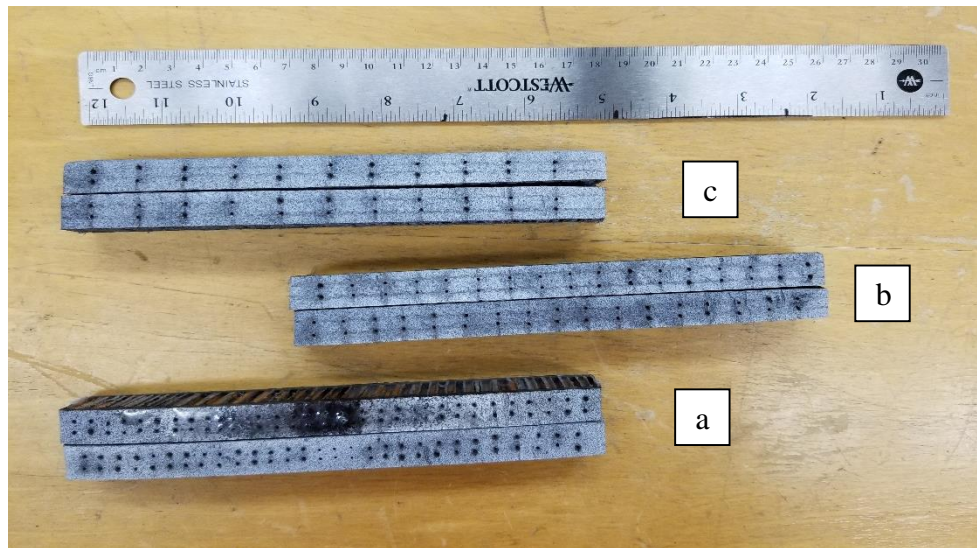

Fig. 4. 4 Sandwich structured beams with different spacing between drilled holes,

a) $L= 5$ mm, b) $2L = 10$ mm, c) $3L = 15$ mm

The drilled holes were then filled with a low viscosity epoxy INF-211 and INF-114 to the ratio of 3.65:1 by weight respectively. The protruded carbon fiber rods of size 0.5 mm were inserted in the

drilled holes with epoxy to flow into it. The smaller the aspect ratio of the rods, the larger the strength. We were using a $\varnothing 0.75\text{mm}$ drill-bit for drilling holes to insert protruded rods $\varnothing 0.5\text{mm}$. Later, we were successful in drilling smaller holes than $\varnothing 0.75\text{mm}$ as of $\varnothing 0.5\text{ mm}$. Thus, the protruded carbon fiber rods can be even smaller than that i.e. to say $\varnothing 0.3\text{mm}$, which also decreases the aspect ratio of the rods and thus increases the strength of the material.

The samples were kept to cure overnight. To check if enough epoxy was flowing to repair de-bond, we cut the samples after all testing was completed. A close look at the rods was taken using the Dino-Lite Digital microscopic images. It was found that enough epoxy flowed into the holes to make sure there was a strong bond of the carbon fiber rods with the surface. This can be clearly seen from the pictures in Figure 4.6, displaying the side view and top view of the half cut samples after all testing were completed.



Fig. 4. 5 Epoxy Resin and Hardener



Fig. 4. 6 Digital Microscope Images of the Sandwich Structured Sandwich beams cut in half

4.4 Experimental Results of Carbon fiber sandwich Structures beam

The experimental efforts consisted of four point static loading of sandwich beams with $[0/90_2/0]_s$, carbon fiber unidirectional 8 plies face-sheet on each side. The experimental results consisted of load and displacement curves obtained after carrying out compression test on the MTS compression testing machine. The test was carried out to check the load that pristine samples carried until de-bond was generated between a face-sheet and honeycomb core. The damaged samples were then repaired and tested again (termed as 'Repaired') for its strength.

The results consisted of 3 different pairs of repaired samples, tested with different spacing of L, 2L and 3L in-between the carbon fiber rods inserted as shown in Figure 14. The experimental results show that the repaired samples always gained better strength than pristine in all conditions of spacing between the drilled holes, but it also showed that there was a strong dependence of the spacing in between the drilled holes for increase in strength which can be clearly seen from the load vs displacement curves shown in Figure 4.7.

Table 4. 1 Samples with max loads with different spacing (Pristine & Repaired)

Spacing between drilled holes (L=5mm)	Max Load Pristine(N)	Max Load Repaired(N)	Thickness (mm)	Width (mm)
3L	1337.64	1419.48	24.5	12.5
3L	1351.6	1480.53	25.8	12.95
2L	1319.88	1503.6	25.4	12.8
2L	860.85	1456.9	25.5	12
L	1126.55	1598.15	25.5	12.95
L	768.58	1655.65	25.5	13.1

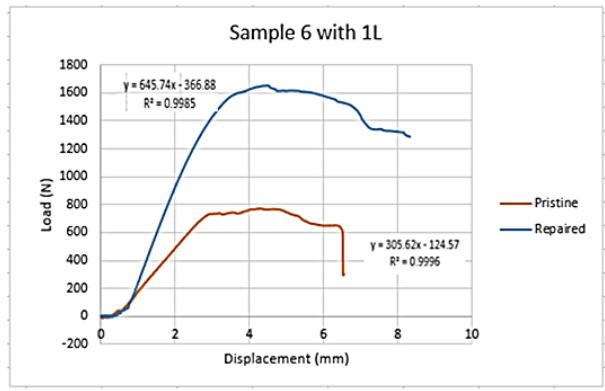

a) Load Vs Displacement Of Sample with L= 5 mm

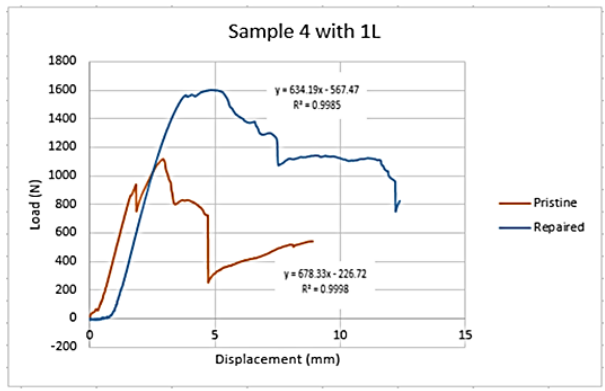

b) Load Vs Displacement Of Sample with L= 5 mm

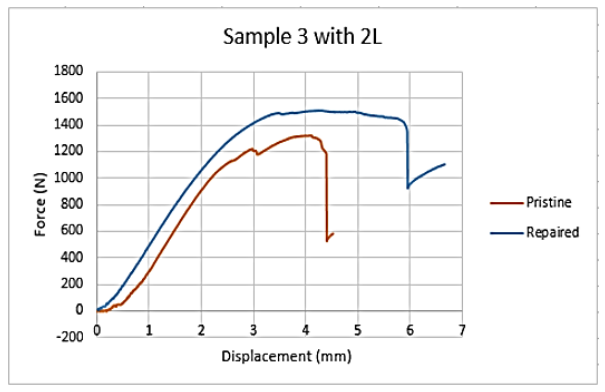

c) Load Vs Displacement Of Sample with 2L= 10 mm

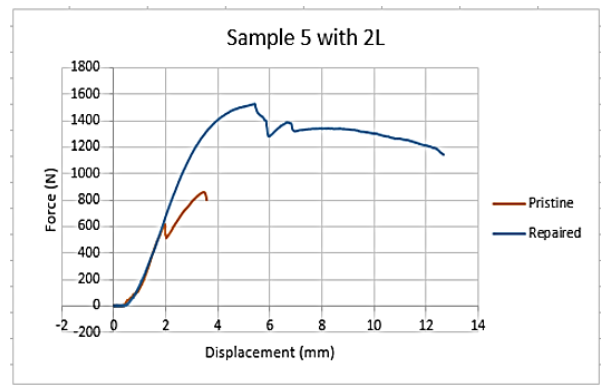

d) Load Vs Displacement Of Sample with 2L= 10 mm

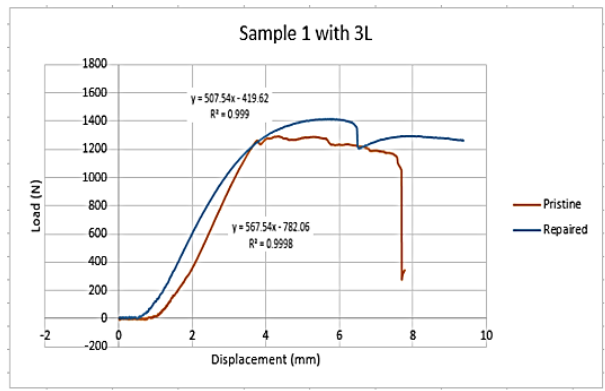

e) Load Vs Displacement Of Sample with 3L= 15 mm

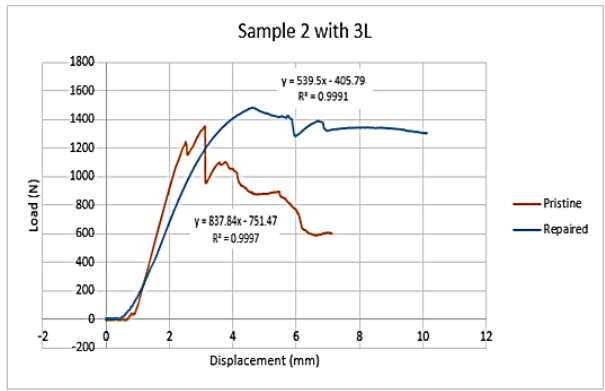

f) Load Vs Displacement Of Sample with 3L= 15 mm

Fig. 4. 7 Load Vs Displacement graphs of pair of samples with L, 2L & 3L spacing between the drilled holes. (L = 5mm)

4.5 Flexural stress calculations of Sandwich beams

For calculation of flexural stress, let's consider Figure 16 with Shear force (SFD) and bending moment diagram (BMD). For samples with length 180 mm and varying thickness and width, the flexural stress can be calculated as shown below.

Flexural stress $\sigma_{\max} = MY/I$, where $M = P x/2$,

$Y = t/2$, ($t = \text{thickness}$)

$I = 1/12*(t)*(h)^3$, ($h = \text{width}$)

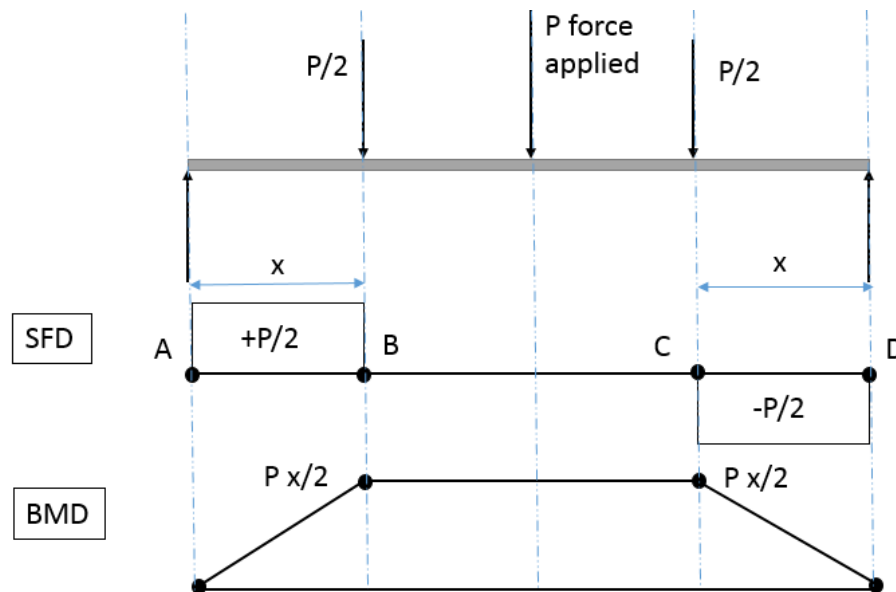

Fig. 4. 8 Shear force and Bending Moment Diagram

Table 4. 2 Flexural stress of pristine and repaired samples

Sample	Max load pristine(N)	Max load repaired(N)	Flexural stress pristine(N/mm ²)	Flexural stress Repaired(N/mm ²)
1	1337.64	1419.48	114.81	↑147.86
2	1351.6	1480.53	112.024	↑122.71
3	1319.88	1503.6	113.286	↑121.941
5	860.85	1456.9	89.67	↑151.76
4	1126.55	1598.15	93.37	↑132.45
6	768.58	1655.65	62.96	↑135.647

4.6 Digital Image correlation Results

The digital 3D image correlation system was used for determination and analysis of deformation and strain data of the samples. It offers a stable solution for full-field and point-based analyses of test objects of just a few millimeters up to structural components of several meters in size. We were able to capture real-time image and video of deformation that occurred during the four point bending test carried out on sandwich beams to better analyze the defects and accordingly act for the repair remedies.

The setup of Digital Image Correlation (DIC) was subjected to the type of experiment and analysis you want to carry out. We were most interested to see where the crack is growing for de-bond between the carbon fiber face-sheet and the honeycomb core and until when. We were able to find out the de-bond generating very clearly and were able to capture good data with images and videos, and some of them are shown below.

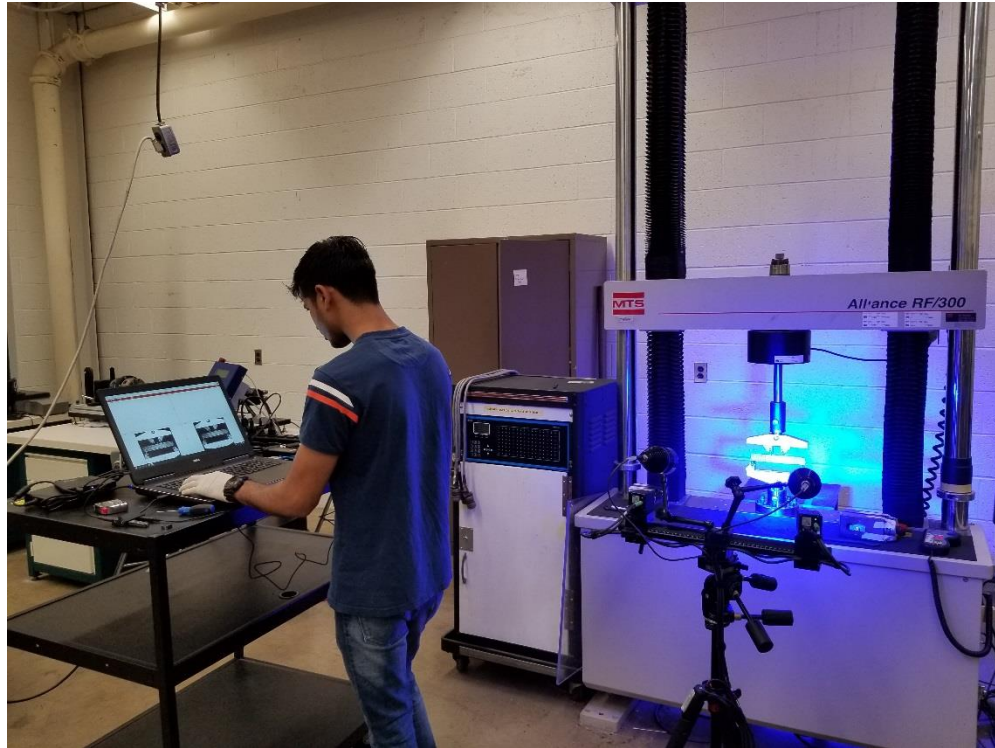

Fig. 4. 9 Digital Image Correlation Setup for Analysis of Four Point Bend test

From the images taken by DIC for sample 1, we can clearly see that there is de-bond generated between the face-sheet and core in the pristine sample while carrying a max load of $\sim 1338\text{N}$. Then, looking at the repaired sample, while testing, it was able to take up to $\sim 1420\text{N}$ max load and we can see the core crushing instead of de-bond that slides the top layer. The test concluded that de-bond was repaired and was able to take more load than the pristine samples. The same trend was seen in all 6 samples that we tested and repaired.

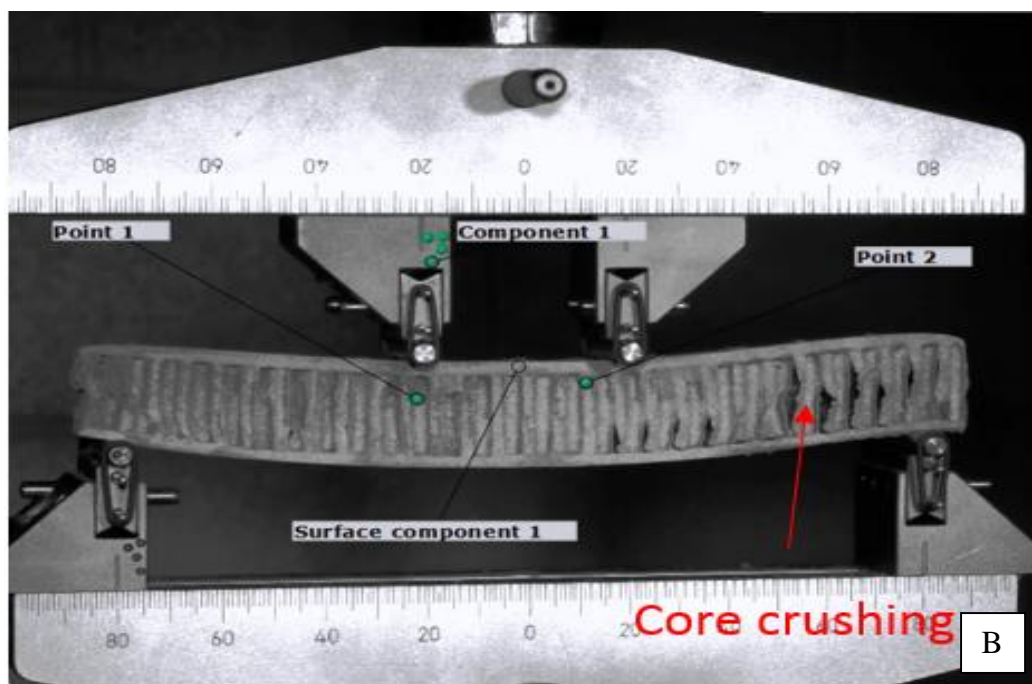
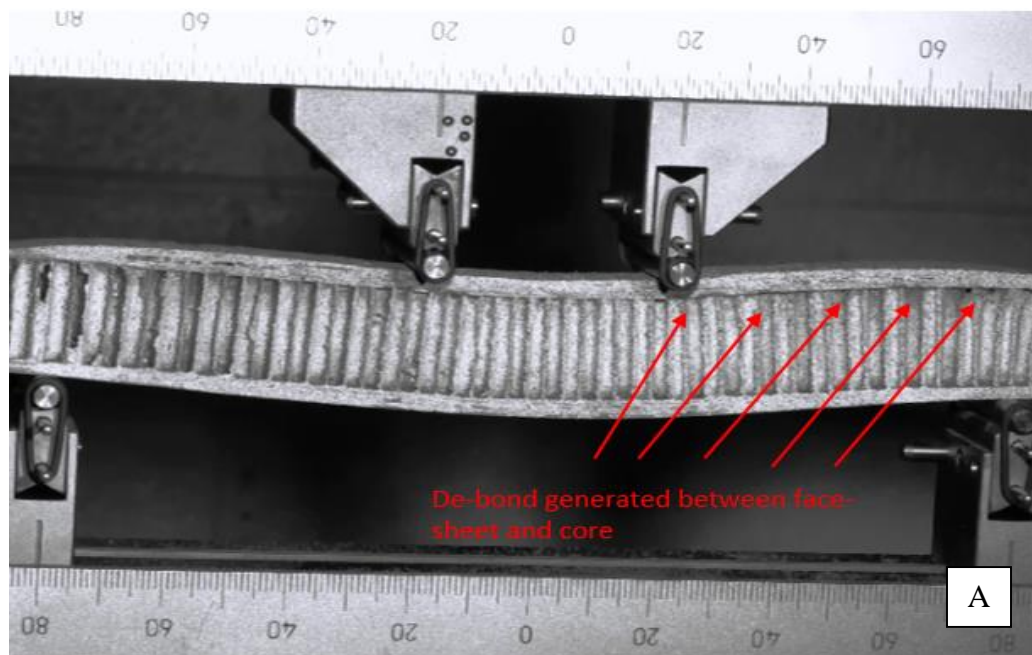

Fig. 4. 10 DIC images of Carbon fiber sandwich panel four point bend test

A) Test carried out on Pristine Sample where de-bond was generated,

B) Test carried out on Repaired sample where de-bond was repaired.

4.7 Outcome of the experiments

Results of experiments with the shorter span samples i.e. 6" that we tested earlier in this section, show the difficulty for clear visibility of the de-bond occurring. Therefore, in order to increase the Moment (M) of the sample we increased the span of the sample by 22"x1"x1/2" (Length x Width x height) and also to increase the bending stress of the sample to reduce the chances of core crushing, we reduced the thickness of the honeycomb core. Earlier, the face-sheet was made up of 8 plies, which was now reduced to 2 plies. The other change included in new samples was that they were prepared with some implanted through-width de-laminations (Teflon film) between the face-sheet and core of size 2" in the middle of the sample. After test, Results concluded that de-bond is generated clearly between the honeycomb core and face-sheet easily using the larger span of a sample.

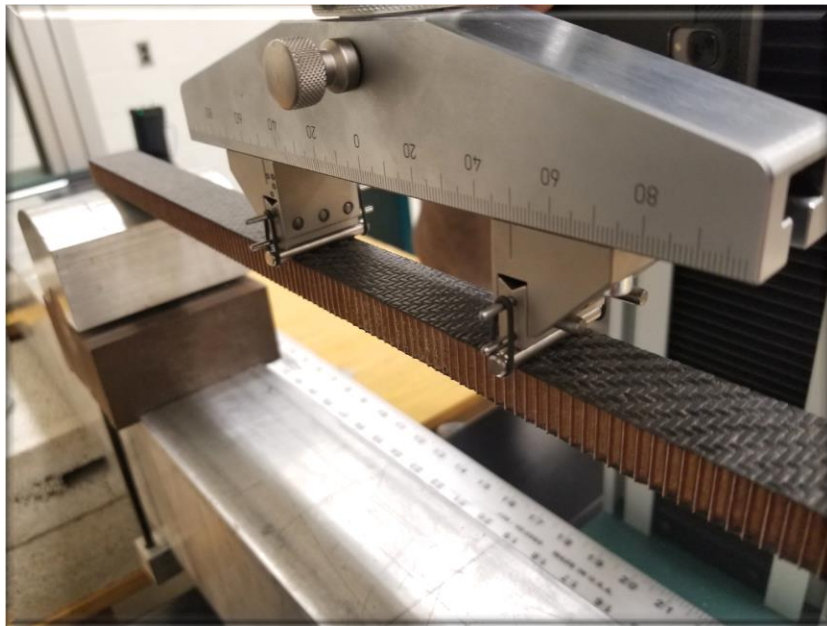

Fig. 4. 11 Larger span sandwich panels

A total of 6 samples were prepared out of which 2 samples were introduced with through-width delamination between the face-sheet and core of size 2" width Teflon film. The four-point bend test was carried out with the top roller and bottom roller at 6" and 20" apart respectively. Also, DIC results were taken and some of the pictures shown below demonstrate that a better de-bond can be generated for carrying out the repair using a 'through thickness reinforcement' technique, which also justifies the Max loading conditions comparison between pristine and repaired samples.

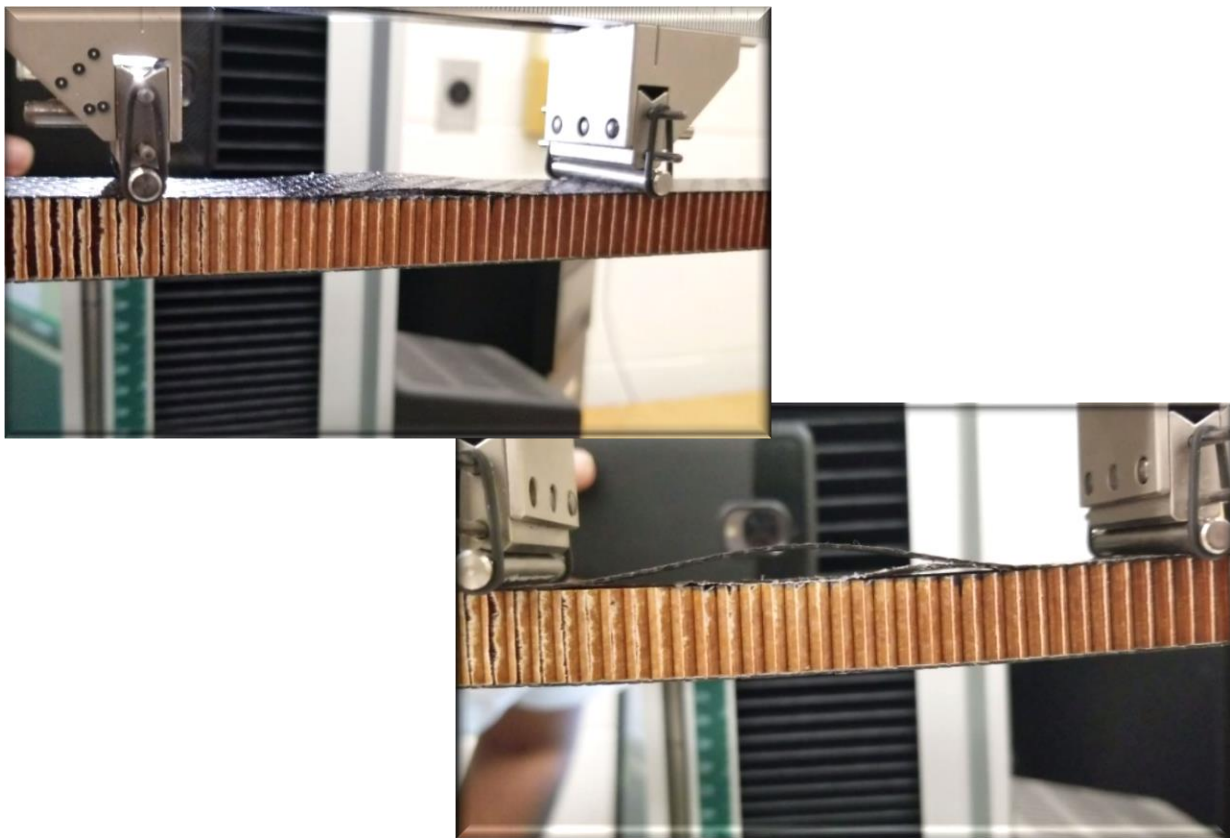

Fig. 4. 12 Larger span Sandwich panels with clear de-bond

Table 4. 3 Max Load and Flexural Stress of Larger Span Sandwich Structures

Sample	Max. Load Pristine(N)	Max. Load Repaired(N)	Flexural Stress Pristine(N/mm²)	Flexural stress Repaired(N/m²)
1	183	Not repairable	22.27	-
2	178	-	22.14	-
3	197	-	24.07	-
4	75	-	9.12	-
5(with delam)	15	173	0.0718	21.05
6(with delam)	13.8	215	1.695	26.40

CHAPTER 5

OTHER APPLICATIONS

5.1 Robotic Drilling in Complex Postures

After analysis and validating that HRC works better than the Robot only method, further experiments were carried out where there is a need of drilling in different orientations like a car door panel, aircraft wing, etc. as mentioned in the related works. The experiment was carried out on wood at different orientations. To make the process faster and more efficient, a 'Learn by Demonstration' method was used, where we can take the robot easily to the place of drilling and assign the base frame from the *Intera* software.

We can easily program a pattern of drilling, spacing between the holes to be drilled, max translational speed, max translational acceleration, max rotational speed, max rotational acceleration, force to be applied in a particular direction, etc. We were more interested in the speed of the approach for drilling, force that is applied while drilling to get better quality and diameter of the drilled hole. Also, to show the capability of the robot and how easily the orientations can be changed, we assign a task to the robot and get the task done more efficiently than the human alone can.

The drilling was carried out in different orientations as horizontally, vertically and at an angle of 45° applying the force of 3N in each direction of drilling respectively drilling a pattern of 4 holes in each orientation pre-assigned to the robot using learn by demonstration mode. The maximum translational speed and maximum translational acceleration was kept as 25 mm/s and 50 mm/s² respectively.

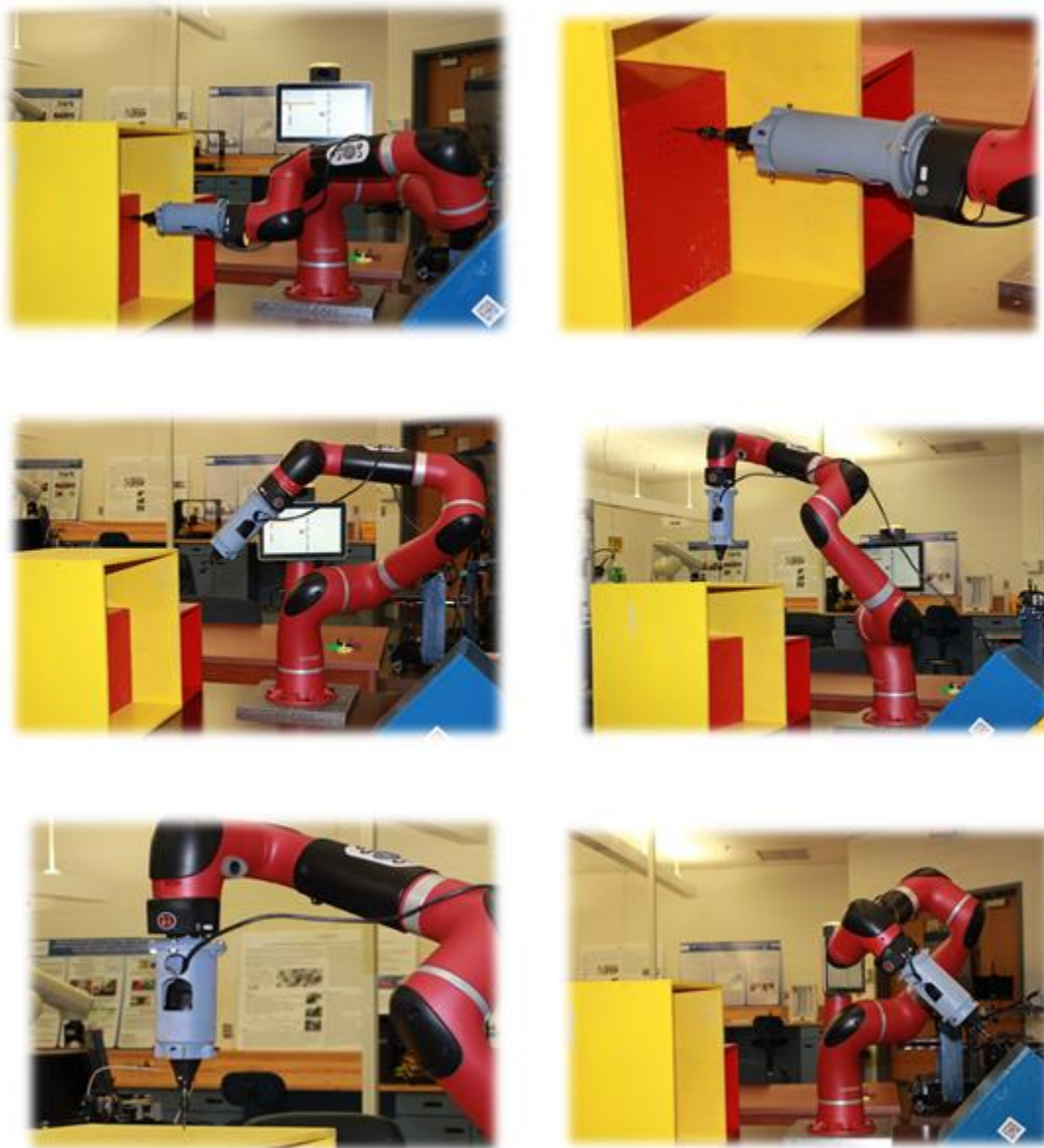

Fig. 5. 1 Sawyer Robot drilling in different orientations

5.2 Robotic Micro-drilling for orthopedic applications

Bone drilling is a very essential part of various orthopedic surgeries, including internal fixation and for attaching prosthetics. A very critical thing in bone drilling is the estimation and control of drilling force to prevent drill-bit breakthrough, excessive heat generation and mechanical damage to the bone. Also, there is a need to drill very precise holes to prevent damage to bone tissues requiring control over feed rate of the drill.

It has always been difficult to design a drill with force feed-back control, which makes it bulky and prevents usage over limited areas. The Sawyer robot that we used for the experiment to be carried out on beef bone has a built-in force sensor which provides the live feed on the software of force getting applied. It also lets us control over feed rate, and force to be applied on a given object. Many experiments were carried out using different sizes of drill-bits and different forces 4N, 5N & 6N. The smallest drill-bit size that was used to drill holes on bone was \varnothing 0.75 mm. Also, tests were carried out using \varnothing 1.5 mm and \varnothing 1 mm. After drilling the holes, analysis of the holes was done for quality and diameter of the drilled holes with the help of digital microscope, which showed that there was less than ± 0.10 tolerance between the actual drill-bit size and drilled holes.

The advantage of robotic drilling over conventional drilling is that the former lessens the chances of applying excessive force, feed rate can be easily controlled via software, and human-robot collaboration makes it more interesting where a human has full control over the robot during the whole task in case anything goes wrong.

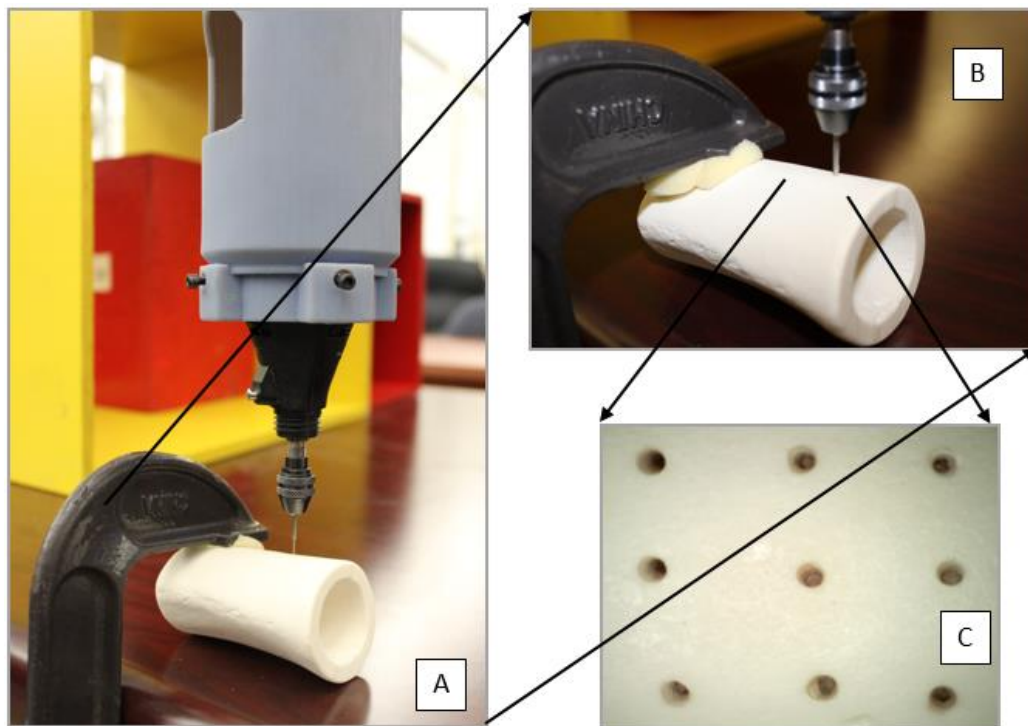

Fig. 5. 2 Sawyer Robot Drilling on Beef Bone, A) Sawyer Robot drilling, B) close look at drilling, C) Magnified image of drilled holes taken by digital microscope

CHAPTER 6

CONCLUSIONS AND FUTURE WORKS

6.1 Conclusion

We were able to develop safe human robot collaboration while carrying out semi-automated robotic drilling. We developed a systematic methodology that enables us to apply a calculated amount of force with compliant approach speed while completing robotic drilling in different orientations and applications. Results on drilling composite material showed that there was less than a $\pm 0.05\text{mm}$ error in drilling as small as $\text{Ø } 0.5\text{mm}$ holes. The composite carbon fiber panels repaired from the '*through thickness reinforcement*' technique showed improvised results after repair and were able to take more load than pristine samples. Also, we were successful in carrying out some experiments drilling on beef bone, for some applications in medical surgery.

6.2 Future Work

Although the design and experiments which we carried out met with success, there are many adaptations, tests and experiments that are left for future work due to lack of time. Some of the future work may include:

- 1) Designing and building the support of a robot that will make sure there is not enough vibrations when carrying out drilling experiments which is here completed by a human and making the process fully automated.
- 2) During the repair of a carbon fiber sandwich pane, after drilling the holes, it is necessary to insert very small carbon fiber rods of size 0.5mm. It was completed by a human in our

work, but an adapter can be designed for the Sawyer Robot in such a way that it can insert rods into drilled holes without any difficulty of it being small.

- 3) Also, while drilling we had to make sure that the drill-bit maintains its temperature. For bigger drill-bits, there is not much chance of breaking due to temperature but for smaller drill-bits, it's one of the main reasons for breakage. Thus, some system or design should be made accordingly with the drill design such that enough coolant is provided while drilling to make sure the temperature of the drill-bit is maintained.
- 4) The Sawyer Robot has a feature that allows it to use a camera to learn the object, which can be used to carry out self-setting of orientations and the position for drilling which is done either by '*learn by demonstration*' mode or by a human using software.
- 5) Also, more studies can be done in the field of surgical robotics, where surgeons might need a specific amount of force, clearance and control over robot.

.

References

- [1] Grilo, T. J., R. M. F. Paulo, C. R. M. Silva, and J. P. Davim. "Experimental delamination analyses of CFRPs using different drill geometries." *Composites Part B: Engineering* 45, no. 1 (2013): 1344-1350.
- [2] B. Hempstead, R. DeVlieg, R. Mistry, and M. Sheridan, "Drill and drive end effector", SAE Technical Paper 2001-01-2576, 2001.
- [3] E. Whinnem, G. Lipczynski, and I. Eriksson, "Development of orbital drilling for the boeing 787", SAE Int. J. Aerosp. 1, Vol. 1, pp. 811-816, 2009.
- [4] Zou C, Lui F. "An off-line programming system for flexible drilling of aircraft wing structures", *Assembly Automation* 2011;31(2):161-8.
- [5] J. Liang, S. Bi, "Design and experimental study of and end-effector for robotic drilling", *Int. J. Adv. Manf. Technol.* 50 (2010) 399-407. <http://dx.doi.org/10.1007/s00170-009-2494-9>.
- [6] A. Frommknecht, J. Kuehnle, I. Efenberger, and S. Pidan, "Multi-sensor measurement system for robotic drilling," *Robotics and Computer-Integrated Manufacturing*, vol. 47, pp. 4–10, 2017.
- [7] DeVlieg R (2009) Robotic trailing edge flap drilling system. In: SAE2009 AeroTech Congress & Exhibition. Automated Fastening/Assembly & Tooling (AeroFast)-Automated Robotic Drill and Fastening Systems. Washington State Convention and Trade Center, Seattle, Washington. SAE Technical Papers 2009-01-3244
- [8] DeVlieg, R., "High-Accuracy Robotic Drilling/Milling of 737 Inboard Flaps," *SAE Int. J. Aerosp.* 4(2):1373-1379, 2011, doi: 10.4271/2011-01-2733.

- [9] DeVlieg R, Szallay Todd (2010) Applied accurate robotic drilling for aircraft fuselage. SAE Technical Papers 2010-01-1836
- [10] Biao Mei, Weidong Zhu, Yinglin Ke, (2018) "Positioning variation analysis and control for automated drilling in aircraft manufacturing", *Assembly Automation*, Vol. 38 Issue: 4, pp.412-419, <https://doi.org/10.1108/AA-01-2018-009>
- [11] Lee, W.-Y., Shih, C.-L., 2006. "Control and breakthrough detection of a three-axis robotic bone drilling system", *Mechatronics* 16(2), 73-84.
- [12] Louredo M, Diaz I, Gil J. "Dribon: a mechatronic bone drilling tool", *Mechantronics* 2012;22:1060-6.
- [13] W. Zhu, W. Qu, L. Cao, D. Yang, and Y. Ke, "An off-line programming system for robotic drilling in aerospace manufacturing," *Int. J. Adv. Manuf. Technol.*, vol. 68, no. 9–12, pp. 2535–2545, Oct. 2013.
- [14] MEI B., ZHU W., DONG H., KE Y., 2015, Coordination Error Control for Accurate Positioning in Movable Robotic Drilling, *Assembly Autom.*, 35, 329-340
- [15] Zou, C. and Liu, F., "An off-line Programming System for Flexible Drilling of Aircraft Wing Structures", *Assembly Automation*, V.31(2), pp 161-168, 2011.
- [16] Shen Peng, Feng Guo-dong, Cao Tian-yang, Gao Zhi-qiang, Li Xi-Sheng, "An intelligent otologic drill", 2014, *Journal of Otology*, pages 104-110- [https://doi.org/10.1016/S1672-2930\(10\)50022-9](https://doi.org/10.1016/S1672-2930(10)50022-9).
- [17] Green JD, Shelton C, Brackmann DE, "Latrogenic facial nerve injury during otologic surgery". *Laryngoscope* 1994; 104(8): 922-926.

- [18] Wormald PJ, Nilssen EL, "Do the complications of mastoid surgery differ from those of the disease?," *Clin Otolaryngol Allied Sci.*, 1997; 22(4): 355-357.
- [19] W.-Y. Lee and C.-L. Shih, "Control and breakthrough detection of a three-axis robotic bone drilling system," *Mechatronics*, vol. 16, no. 2, pp. 73– 84, 2006.
- [20] Coulson CJ, Taylor RP, Reid AP, et al. An autonomous surgical robot for drilling a cochleostomy: preliminary porcine trial. *Clin Otolaryngol* 2008;33(4): 343 – 347.
- [21] Sui, J., Sugita, N., Ishii, K., Mitsuishi, M., 2014. "Mechanistic modelling of bone-drilling process with experimental validation". *J. Mater. Process. Technol.* 214,1018-1026.
- [22] Shim, Seongbo, Hyunseok Choi, Daekeun Ji, Wongin Kang, and Jaesung Hong. "Robotic System for Bone Drilling Using a Rolling Friction Mechanism." *IEEE/ASME Transactions on Mechatronics* (2018).
- [23] Wang, Wendong, Yikai Shi, Ning Yang, and Xiaoqing Yuan. "Experimental analysis of drilling process in cortical bone." *Medical engineering & physics* 36, no. 2 (2014): 261-266.
- [24] Kasahara, Yusuke, Hiromasa Kawana, Shin Usuda, and Kouhei Ohnishi. "Telerobotic-assisted bone-drilling system using bilateral control with feed operation scaling and cutting force scaling." *The International Journal of Medical Robotics and Computer Assisted Surgery* 8, no. 2 (2012): 221-229.
- [25] Alici, Gürsel. "A systematic approach to develop a force control system for robotic drilling." *Industrial Robot: An International Journal* 26, no. 5 (1999): 389-397.

- [26] Alici, G., and R. W. Daniel. "Compliant robot drilling dynamics and their implications for remote drilling tasks." In Proc. 2nd International Conference on Automation, Robotics, and Computer Vision, Singapore, September, pp. INV-3.1. 1992.
- [27] Moore, S. R., and N. Hogan. "Part referenced manipulation-a strategy applied to robotic drilling." *Control of Manufacturing Processes and Robotic Systems* (1983): 183-191.
- [28] Allotta, B., F. Belmonte, L. Bosio, and P. Dario. "Study on a mechatronic tool for drilling in the osteosynthesis of long bones: tool/bone interaction, modeling and experiments." *Mechatronics* 6, no. 4 (1996): 447-459.
- [29] Roadinger, T. J., and M. A. Townsend. "Torque and thrust parameters in drilling using dimensional analysis." *Journal of Engineering for Industry* 102, no. 1 (1980): 37-44.
- [30] Alici, Gürsel, and Ron W. Daniel. "Robotic drilling under force control: execution of a task." In *Intelligent Robots and Systems' 94. 'Advanced Robotic Systems and the Real World', IROS'94. Proceedings of the IEEE/RSJ/GI International Conference on*, vol. 3, pp. 1618-1625. IEEE, 1994.
- [31] Briones, Juan Antonio, Eduardo Castillo, Giuseppe Carbone, and Marco Ceccarelli. "Position and force control of a parallel robot capaman 2 bis parallel robot for drilling tasks." In *Electronics, Robotics and Automotive Mechanics Conference, 2009. CERMA'09.*, pp. 181-186. IEEE, 2009.
- [32] Everson, Curt E., and S. Hoessein Cheraghi. "The application of acoustic emission for precision drilling process monitoring." *International Journal of Machine Tools and Manufacture* 39, no. 3 (1999): 371-387.

- [33] Rahim, Erween Abd, Kamaruddin Kamdani, and Safian Sharif. "Performance evaluation of uncoated carbide tool in high speed drilling of Ti6Al4V." *Journal of Advanced Mechanical Design, Systems, and Manufacturing* 2, no. 4 (2008): 522-531.
- [34] Ralph, W. Carter, W. Steven Johnson, Paul Toivonen, Andrew Makeev, and J. C. Newman Jr. "Effect of various aircraft production drilling procedures on hole quality." *International Journal of Fatigue* 28, no. 8 (2006): 943-950.
- [35] Kurt, M., Y. Kaynak, and E. Bagci. "Evaluation of drilled hole quality in Al 2024 alloy." *The International Journal of Advanced Manufacturing Technology* 37, no. 11-12 (2008): 1051-1060.
- [36] Lee, JuEun, Craig L. Chavez, and Joorok Park. "Parameters affecting mechanical and thermal responses in bone drilling: A review." *Journal of biomechanics* (2018).
- [37] Cheong, Man Sheel, Dong-Woo Cho, and Kornel F. Ehmann. "Identification and control for micro-drilling productivity enhancement." *International Journal of Machine Tools and Manufacture* 39, no. 10 (1999): 1539-1561.
- [38] Brett, P. N., Baker, D. A., Reyes, L., & Blanshard, J. (1995). An Automatic Technique for Micro-Drilling a Stapedotomy in the Flexible Stapes Footplate. *Proceedings of the Institution of Mechanical Engineers, Part H: Journal of Engineering in Medicine*, 209(4), 255–262. https://doi.org/10.1243/PIME_PROC_1995_209_352_02
- [39] NIST. Available: <https://www.nist.gov/industry-impacts/human-robot-collaboration>
- [40] Prof. Dr. Rainer Müllera, Dipl.-Wirt. (FH) Matthias Vette M., Aaron Geenen M. ‘ ‘Skill-based dynamic task allocation in Human-Robot-Cooperation with the example of welding application’ ’

- [41] Feldmann, K.; Schöppner, V.; Spur, G. “*Handbuch Fügen, Handhaben, Montieren.*” Hanser München, 2014. Pp. 327-335.
- [42] Gil Boyé de Sousaa,*, Adel Olabia, Jorge Palosa, Olivier Gibarua Arts et Métiers Paristech, 8 Boulevard Louis XIV, 59000 Lille, France. “3D metrology using a collaborative robot with a laser triangulation sensor”.
- [43] “Collaborative manufacturing with physical human–robot interaction”. Andrea Cherubini, Robin Passama, André Crosnier, Antoine Lasnier, Philippe Fraisse. Department of Manufacturing Engineering, PSA Peugeot Citroën, Route de Gisy, 78140 Vélizy Villacoublay, France
- [44] Windhorst, Torsten, and Gordon Blount. "Carbon-carbon composites: a summary of recent developments and applications." *Materials & Design* 18, no. 1 (1997): 11-15.
- [45] “Compressive strength of composite laminates with inter-laminar defects”. John W. Gillespie, Jr. R. Byron Pipes.
- [46] Williams, Hugo R., Richard S. Trask, and Ian P. Bond. "Self-healing composite sandwich structures." *Smart Materials and Structures* 16, no. 4 (2007): 1198.
- [47] “A smart repair system for polymer matrix composites” by S.M. Blaey, C. B. Loader, V.J. Hawyes, L. Humberstone, P. T. Curtis.
- [48] (2018). Polyjet Materials. Available: <https://www.stratasysdirect.com>
- [49] Craig Friedrich, “Precision Micro-manufacturing Processes applied to miniaturization technologies”. Available: <http://pages.mtu.edu/~microweb/chap6/ch6-0.htm>

[50] Tsai, Tzung-Cheng, and Yeh-Liang Hsu. "Development of a parallel surgical robot with automatic bone drilling carriage for stereotactic neurosurgery." *Biomedical Engineering: Applications, Basis and Communications* 19, no. 04 (2007): 269-277.

[51] Sawyer Robot and Intera Studio main page. Available: http://mfg.rethinkrobotics.com/intera/Main_Page

[52]] Lughmani WA, Bouazza-Marouf K, Ashcroft I. "Drilling in cortical bone: a finite element model and experimental investigations". *J Mech Behav Biomed* 2015;42:32–42.

[53] Marino A, Cirillo P, Natale C, Chiacchio P, Pirozzi S (2016) A general low-cost and flexible architecture for robotized drilling in aircraft assembly lines. In power electronics, electrical drives, automation and motion (SPEEDAM), 2016 International Symposium, pp 1401–1408

[54] Eguti, Carlos Cesar Aparecido, and Luis Gonzaga Trabasso. "Design of a robotic orbital driller for assembling aircraft structures." *Mechatronics* 24, no. 5 (2014): 533-545.

[55] Available: http://www.admatis.com/eng/competencies_material_science_sandwich.html

[56] 2011 U.S. Navy photo by Victor Pitts/Released on Dec. Available: <http://www.navair.navy.mil/index.cfm?fuseaction=home.NAVAIRNewsStory&id=4865>

VITA

Parimal Mahesh Prajapati was born in Vapi, GJ, INDIA on October 4th 1994. He graduated from the University of Mumbai in 2015 with a Bachelor of Science in Aeronautics and also pursued an Aircraft Maintenance Engineering diploma from Bombay Flying Club, College of Aviation. He worked at Bombay Flying Club in on the job training for 6 months while pursuing his bachelor's degree, gaining wide knowledge of aircraft engines and structures. He later joined Toyota Motors Pvt. Ltd., as a Technician Trainee where he gained automotive knowledge and skills. To advance his career, he enrolled to pursue Master of Science degree in Mechanical Engineering at Old Dominion University in 2016, where he gained advanced knowledge in the field of Mechanical Engineering especially in Robotics, Automation, Design and Manufacturing. At ODU, he has worked as a teaching assistant for more than 3 semesters and worked under Dr. KN Kaipa to gain extensive knowledge and skills in Robotics.